

1

1

W € | ‡z € 1uv † 1_ v ‡' † ty ^ ‡' v † 1s v z 11

' ^ € vy ~ v € uv .. 1Vz € † f v z † ^ € x 1r ^ † 11

] v z † ‡ ^ € x † v } v | ‡ .. € z | 1

1

â † = ‡ ' ê ! = † " - i ‡ ' ð M ÷ - M ° i " M { â M] 5 = ð " ë = ð d † i ê i ð ž ð M M

f i ! - M] ð ! ° i " M M

M

] 5 = ð " ë " i \$ " è = ‡ ' d : ð " è M ! ë - i ‡ ' ð " - † d = i " - ð " - M à - f i " ! \$! è \$ M

! è ° M â ! = f i - é ! è \$ " è M d ! : M ° i " M & - " - ! " è f i = ð d † i ê i ð ž ð M M

' " = ð d è ° = d ! : è d ' ë " M ! è ° M b d y è d ' ë " è M

1

g v . w † t v . K 1	Y , } x v . 1 \ y € = 1 e v € € v e 1 e d ` 1 X ~ s Y = 1 S r C E v ^ t y 1
1 1	Y v € u . z 1 W y . z € x = 1 R ~ f . z € 1 X ~ s Y = 1 U , . ‡ ~ ^ € u 1
1 1	T y . z † † , f y 1 S ^ † t v . v . = 1 e z - , 1 \ v z } = 1 e . r € † € v † S h 1 X ~ s Y = 1 d † † x r . †
1 1	R } v < r € u v . 1 S . . € € v = 1 F A Y v . † 1 e . r € † ~ z † † z € 1 X ~ s Y = 1 S v . } z € 1
V . † t v } } K 1	g B > B 1 z - 1 _ , % ~ s v . 1 C A B I 1
1 1	1

M

M

M

1

||

^ r € r x v ~ v € † d ^ ~ ~ r . . € 1

1

^ . . . t t y } † † v z † € x 1

U ^ . . t y 1 v z € v 1 ^ € v y ~ v € u v 1 V z € † f v z † € x 1 r ^ † †] v z † € x t v } | † . . € † 1 p € u v . € † † z y 1 u z v 1 \ ^ . . . t t y } † † % . y p } † > € z † t v 1 z ~ 1 _ v † ? U r s v z † S z u 1 v z € v 1 g v . . z € x v . . € x 1 u v . 1 \ ^ . . . t t y } † † v z † € x 1 s v z † p € u v . . € x 1 u v . 1 V z € † f v z † € x 1 u ^ . . t y 1 u v € 1 ^ € v y ~ v € u v 1 _ v † r ^ † t s r ^ † € u 1 u ^ . . t y 1 u z v 1 u r . r ^ † † w } x v € u v 1 y y v . v 1 g v . r ^ † t t y ^ € x 1 † v z † S v z t v 1 S z u v . .] , ~ f v € † z . † 1 u z v 1 \ ^ . . . t t y } † † v z † € x 1 u v † †] ^ . . . t t y } † † † † . . ~ t t y S † p t y † † v € 1 \ € , † v € 1 u v † † [r y . v † † C A B B 1 S z . 1 r ^ † t y 1 z € 1 k ^ | ^ € v † r € 1 | v z € v . 1 d † v } } v 1 z ~ 1 _ v † 1 ^ € † v . † t t y . z † v € 1 S v . u v € ? Y z € ^ †] , ~ ~ † = † u r † † 1 u z v 1 z ~ 1 Y t y † † † f r € € € x † f € v † 1 r € x v S v € u v † v € 1 d t y ^ † f . z € † z f z v € 1 S v z v † † x v y v € u 1 % € 1 u v . . Y y v 1 u v † † d † . . ~ v † † ^ € r s y p € x z † † € u ? 1 U z v 1 u v . . v z † 1 % . S v € u v † v € 1 d t y ^ † f . z € † z f z v € 1 ^ € u 1 u z v 1 V ~ f v € u } z t y | v z † 1 u v . 1 u v . . v z † 1 v z € x v t v † † v € 1 d t y ^ † v z € . z y † € x v € 1 . v z t y v € 1 r ^ † t y 1 z € 1 k ^ | ^ € v † r ^ † † ? 1

1

^ . s v . . t t y S z € x ^ € x v € 1 € u 1 b ^ r } z † p † 1 u v . 1 \ ^ . . . t t y } † † † † . . ~ v 1

S v ^ x } z t y 1 u v . 1 b ^ r } z † p † 1 u v . 1 \ ^ . . . t t y } † † † † . . ~ v 1 v < z † z v . v € 1 u v . . v z † 1 S v u v . 1 R € w . u v . . € x v € 1 r € 1 V . . ! v ^ > x ^ € x † r € } r x v € 1 € , t y 1 r € 1 u z v 1 c , s ^ † † y v z † 1 % € 1 d t y ^ † . v } r z † ? 1 U z v † † | r € € 1 ^ 1 W y } w € | z € v € 1 % € 1 d t y ^ † v z € > . z y † € x v € 1 u ^ . t y 1 ^ € v y ~ v € u v 1 V z € † f v z † € x 1 r ^ † †] v z † € x t v } | † . . € † 1 w y . v € ? 1 V † † S z u 1 u . z € x v € u 1 v ~ f w y } v € = 1 u z v † v € 1 R † f v | † S v z † v . x v y v € u 1 ^ † 1 ^ € † v . † † t y v € 1 9 ? 1 S ? 1 z ~ 1 c r y ~ v € 1 u v † † 1 v z € v . 1 g U V > W _ 1 R . s v z † † . . f f v : 1 ^ € u 1 x x w 1 z € 1 u z v 1 _ , . . ^ € x 1 v z € v } z v ù v € 1 ^ † } r † † v € ? 1 R ^ w u v . 1 r € u v . v € 1 d v z † 1 s v > € † z v € 1 d t y ^ † v z € . z y † € x v € 1 z ~ 1 w y } v . w w z v € 1 S v † . z s 1 u v † 1 _ v † v † † s v . . t t y S z € x ^ € x † † † . . ~ v = † ~ 1 v z € v € 1 y r . † v € 1 S v † . z s † ^ † † € u 1 9 ? 1 S ? 1 V z € † t y r } † . . t y 1 v z € v † 1 e . r € † w . r † † . . t : 1 % € 1 v z € v ~ 1 \ ^ . . . t t y } † † † ^ € † v . > † t t y v z v € 1 ^ † | € € v € ? 1 U r . r ^ † † | € € v € 1 † z y 1 R € w . u v . . € x v € 1 r € 1 v z € 1 ~ v y . 1 † f r € € € x † , ^ v } } v € p y € } z t y v † † 1 g v . y r } † v € 1 } v z † € x t v } | † . . € † z y v . 1 V z € † f v z † v . 1 v . x v s v € = 1 u ? 1 y ? 1 r ^ w ^ s v . . t t y S z € x ^ € x † † † f r € € € x v € 1 z ~ 1 _ v † 1 r | † % b u p ~ f w € u 1 ~ z † ^ s v . . t t y S z € x ^ € x † † † . . ~ v € 1 ^ † 1 . v r x z v € ? 1 R ^ t y 1 y z v . 1 S z u 1 v ~ f w y } v € = 1 u z v † v € 1 s z t y v . . 1 % . € r t y } † † † z † v € 1 V w w | † S v z † v . x v y v € u 1 ^ † 1 ^ € † v . † † t y v € ? 1

1

Y y v . r ^ † } r † † € x 1 u v † † 1 0 s v . † . r x ^ € x † f v † v † 1

^ z † 1 u v € 1 u v . . v z † 1 v z € x v t v † † v € 1 d t y ^ † f . z € † z f z v € 1 z † † 1 v z € v 1 Y y v . r ^ † } r † † € x 1 u v † † 1 0 s v . † . r x ^ € x † f v † v † 1 f . z € † z f z v } 1 . v r } z † v . s r . . ? 1 U z v t v . 1 S v . z y † † s v † t t y . v z † 1 ~ v y . v 1 ^ r ù € r y ~ v € = 1 u z v † t v z v € † 1 u v . 1 _ v † s v † . v z > s v . 1 ^ € u 1 t v z v € † 1 u v . 1 d t y ^ † † t y € † 1 v . x . z w € 1 S v . u v € 1 | € € v € = 1 u r . . € † v . 1 ^ ? 1 r ? 1 ^ € } z v > ^ , € z , z € x 1 9 z ~ 1 _ v † w y . . € x † † † † † v ~ : = 1 R | † % w . . € x 1 % € 1 a v € u v } † f v . . x v € 1 9 w } † 1 v . w . u v . } z t y : 1 ^ € u 1 v z € v 1 ^ f z ~ z v . . € x 1 u v . 1 R € . v x v | v € } z € v 1 9 u ^ . t y 1 u z v 1 d t y ^ † . v } r z t y v . † † v } } v . . ? 1

1

||

1

ZËyr }tt%... v zt y € zt 1

p1 àiè"iò!è\$?!! 1

U1 c i-é=d è "M { d-d è "ò"-||- -||° "è|| \ "òfl=† " !òfl??!!!! 1

C?B1 æd=|| b 8° "èè|| @!-fl=† "è !=è" i=ò! è\$???!!!! 1

C?C1]ò-8è R||! è°M } ...dèè! è\$=-! "èè" è ???G 1

C?D1 |†"-=†' fiè\$!è\$=† "id=ò! è\$M! è°M&è†é" -|| è || \ 8-è dè† "ò-i"†??H 1

C?E1 \ ^ .:tty}† ttt+.,~ ??J 1

C?F1 d r s z z p t 1 % € 1 d æ t y ., € ~ r t t y z € v 1 ???J 1

D1 X .v€' v€1uv.1V ~ f v æ U } z t y | v z t 1 % € 1 d t y ^ † v z € . z t y † € x v € ???BA 1

D?B1 Uz† r €' t t y ^ † ???BA 1

D?B?B1 ^ z € u v t t t + ., ~ v z € t t v } ^ € x ???BA 1

D?B?C1 S r t | ^ f > W € | z € f € r s y p € x z v . 1 0 s v . t t + ., ~ ' v z t t y ^ † 1 9 s f ` T : ?????????????????????????????????BA 1

D?B?D1 V z € v y t t t x v . z € x v . v . 1 \ ^ . . : t t y } ^ t t t t + ., ~ v 1 r ^ v u z v 1 c v t z t r €' v z € t t v } ^ € x 1 % € 1 U z t r €' . . } r z t 1 BA 1

D?C1 V . u > \ ^ . : t t y } ^ t t t t y ^ † ???BB 1

D?C?B1 R } } x v ~ v z € v t B B 1

D?C?C1 X v . z t y t v t v . 1 Z € % . t v . 1 L ^ } } t r € € ^ € x t ' v z t t y ^ † 1 1 \ f c k @ f c ?????????????????????????????????BC 1

D?C?D1 V . u w y j v . > c z t y † € x t % . x } v z t y ???BD 1

D?C?E1 c v t ~ v v 1 BE 1

D?D1] v z t ^ € x t u z w . v € t r } t t y ^ † ???BF 1

D?D?B1 R } } x v ~ v z € v 1 S v t . r t y † € x ???BF 1

D?D?C1 V z € t t v } ^ € x 1 u v t 1 U z w . v € t r } t t y ^ † v t 1 s v z t v z j | , ~ f v € t z v . t v € 1] v z t ^ € x v € ?????????????????????????BG 1

D?E1] d è è "è=† " i " è " è=† " !òfl ???BH 1

D?F1 à " i =ò! è\$=-† " dèò " - j " " = d \$ " " = † " !òfl ???BH 1

Ù1 à èò f i t é ! è \$ M " - || @ ! - f l = † " è ! = è " i =ò! è \$???BI 1

E?B1 à èè \$ " è " i è " = ???BI 1

E?C1] 5 =ò " è =† " òM || à i è : è ! = || j 8 è || c " † " = " è = † " ò " - è || i è M • " " -ò " i è " è f l l d : M @ ! - f l = † " è = " M i è M v t " -ò = d \$! è \$ = è " è f l l c U : 1 BI 1

E?D1 æ " j " è 8 . . è " èòM 8 || à j d i è d t è " M } ' 8 -ò R à i -† i è M { 8 f " - || r è || à " - è d è 5 || - 8 è M U T b p M ! . . M è M U T Ú M c p : M ! è " M æ " è d R] ò " i " M] 5 =ò " è " i " è = è " i =ò! è \$ " è || U T Ú M c U : ???BJ 1

E?E1 , ! = d è è " è : d = ! è \$ M ! è " M " " -ò " i è ! è \$???CA 1

Û1 • " - d -† " iò ! è \$ M | j 8 è || b " = \$ - y " è || r è || j † " !òfl - " è d i = || | è " M à è : 8 - ° " - ! è \$ " è || d è || " - " è || } ! d è iò z ò ?????????????????????????????????????CB 1

F?B1 |† "-=†' fiè\$!è\$ " è || r è || b " = \$ - y " è ???CB 1

F?C1 à èè \$ " è " i è " = || M b " = f " -ò j " - d -† " iò ! è \$ M | è || j † " !òfl - " è d i = ???CC 1

F?D1 à è : 8 - ° " - ! è \$ " è || d è || " i " M } ! d è iò z ò || j 8 è || @ ! - f l = † " è ! = è ò - è " è ???CC 1

F?E1 à è : 8 - ° " - ! è \$ M | è || " i " M } ! d è iò z ò || j 8 è ||] ò - è " è || r è || \ 8 - è d è † " ò - i " † ???CD 1

F?F1 , ! = d è è " è : d = ! è \$ M ! è " M à ! = † è i t é ???CE 1

Ù1 ^ " - d ! = è d =ò ! è \$ M " - || \ " è f l " ???CG 1

G?B1 à èè \$ " è " i è " = ???CG 1

G?C1 b \$ è i t é " M b d y è d ' è " è ???CI 1

V1 , ! = d è è " è : d = ! è \$ M ! è " M à ! = † è i t é ???DC 1

W1 à iò " - d è ! -ò M c " iò " - : " " è " M - è : 8 - è d è i 8 è " è ???DD 1

às1 à è iò d \$ " M] 5 =ò " è =† " òM || à i è : è ! = || j 8 è || c " † " = " è = † " ò " - è ???DE 1



1

's1 âèd\$ "Mæ" èdR]ô! °i "M]5=ô" ë °i "è=ôè" i=ô! è\$ "è 1???DI 1
äs1 âèd\$ "M Mb !ôôRä" ; "êR ! ë -t 'ô" -1???EA 1
1 1

1

B1 Vz}vz^€x1

^ z1 ^ ^ vy~ v€uv~ 1 Vz€tr# 1 uv' v€tr.}v..1 V..v^ x^ €x1 Šv..uv€1 |, €%€tz €v}}v1 R€}rxv€1 ~ z1 d€>
 ty..€xv€v.r.† .v€1%.u.þ€x†1^ €u1u^ .ty1V..v^ x^ €xtr€}rxv€1~ z1]vz† €xtv} | †.. €z 19 V: 1v..tv# #?1
 Uz1uru^ .ty1.vxz €r}1wy}v€uv€1f, †z%€1Vzv€†tyr }v€1uv..1d€ty..€xv€v.r.† .v€1sv' x}zty1\^ .!>
 tty} ††}vz† €x1^ €u1Z€v.†z =1 ayr tv€†€ ~ v.†z=1R^ tx}vzty1%€1dfr €€^ €xttyŠ r€|^ €xv€=1Wz | v..1
 ^ €u1' sv..ttyŠ z€x^ €xv€1~ †tv€1uvtyr }s1u^ .ty1uz1% .s}vzv€uv€1Sv†.zst~ z†v}1z~ 1ösv.†.r.x^ €xt>
 €v# 1, uv..1u^ .ty1v€††f.vtyv€uv1R€w..uv..€xv€1r €1}vz† €xtv} | †.. €z sr †z.†v1V..v^ x^ €xtr€}rxv€1
 r^ }v}v€xv€1S v..uv€?1R€uv.v..tvz†1z†1^ ^ | }p.v€=1Sv}tyv1R€w..uv..€xv€1r €1uz1vz€' v}€v€1\ v€€x...>
 üv€1^ ..1dfr €€^ €xt, ^ r}z†1^ | €vz† Š z€xv€u1v..w..uv.)zty1t€u?1

Z€1uz1tv~ 1Sv.zty†1v.w}x†1vz€v1Sv†.rty† €x1uv..1uv..vz†1fy€z† r}zty1w..1uz1W €| †z €1uv†1_v† >
 tty^ † v†Š z.†.tr~ v€1ar .r~ v†v..1uv†1v} | †..v€v.xz†€†v~ †L1uz†1t€u1z€tsvt, €uv.v1Y yv† €u1b^ r}z>
 ††1uv†1\^ .!> tty} ††††..~ v†?1V†1Š zu1r sxv†ty†† †=1Š z1uz1tv1†zty1v€†Š z | v}€1Š v..uv€1^ €u1ur .r^ †1
 rsxv}vz††1Sv}tyv1^ rù€ry~ v€1v€†Š vuv..1r^ }v}dvz†v€1^ | €vz†v..1] V>sr †z.†v..1V..v^ x^ €xtr€}rxv€1
 ^ €u@ uv..1r^ }v}dvz†v€1uv..1\^ .!> tty} †††ty^ † vz€.zty† €xv€1v..w..uv.)zty1tvz€1S v..uv€?1

Uz1tv~ 1Sv.zty†1}zv€v€1uz1gv.yb}†€z†v1^ €u1V..v€€†z†v1r^ †1uv~ 1Sv†.zvs1%€1Y ty†††fr €€^ €xt>
 €v# v€1^ ^ 1X..€uv?1Uz1Š v†v€†}ztyv€1R^ ††rxv€1uv€1^ ^ 1dty^ † f. z€' z†z€1xv}†v€1{vu, ty1r^ ty1z€1uv€1
 ^ €†v.}rxv.†v€1dfr €€^ €xtvsv€v€?1

1

C1 hz_|†r~vlar...r~v†v...1w ...1uv€1_v†'†ty^†'11

C?B|| Ur†1^ , uv}}| \ ^ ...†ty}^††}vz†^€x 1

Uz1R€w€xt>\^ .!> tty} ††h vtytv}††..~ }vz† €x19\^ .!> K\^ .!> tty} ††}vz† €x: 1z†z€1l Enluvvz€z..†1^ 1
 1 1 N D ° 1 1 1 1 1 1 1 9X}†C>B: 1
 Š, svz1~ z1Z 1uv..1D>f, }zv1\^ .!> tty} ††††..~ 1xv~ vz€†z††1h z.1%.€r ty}††z†v€1x..,ù' xz=1ur††1^ ^ 1
 V..z†} €x1uv†1~ r<z~ r}v€1\^ .!> tty} ††††..~ v†1~ z†1vz€v..1^ ~ 1uv€1W | † .1tNB=B1y yv.v€1b^ v}}v€>
 †fr €€^ €x1xv.vty€v†1Š zu1^ €u1ur††1uz1b^ v}}v€z~ fvur €' 1vz€v..1_v† vz€†fvz†^ €x1vsv€w}}†1^ €†v..1
 k^ x..€uv}vx^ €x1uz1tv†1W | † .†1sv.vty€v†1Š zu?1Uz1\^ .!> tty} ††b^ v}}v€z~ fvur €' 1Š zu1ur €€1^ ^ 1
 1 1 N / 1 1 1 1 1 1 1 9X}†C>C: 1

^ €u1S z1v.yr }†v€1r }†1V..tr# †tyr }tsz†1vz€v†1\^ .!> tty} ††v†1^ €u1r }†1V..}p^ †v..€x1uv..1\^ .!> tty} ††}vz>
 † €x1ur†1€r tyw}xv€uv1Sž†u?1

1

1

1
1

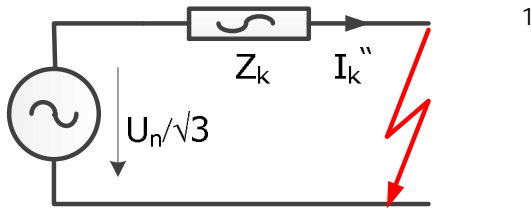

1

Szűű1C>B111
V..tr # ttr }tszűű1vzv1^ ^ .. ttr} ttrv1

1
1

Szűű1C>C11
V..tr # ttr }tszűű1^ ^ ..1Sv^ ..tvz^ Ex1%€1^ sv.>
ttr} zEx^ Exv€1 1

Uv..1Svx.zwuv..1^ ^ .. ttr} ttrvz^ Ex1r #kvxv€ sv..1uv~ 1^ ^ .. ttr} ttrv.. ~ 1uv€1g, ..tvz^=1ur ttrv..1 sv.>
ttr}pxz1tvy..1ttr}v}}1sv1z- ~ 1Sv..uv€1|r €€1^ €u1ur ttrv..1%€1uv..1dfr €€^ Ex1vsv€v1^ €rsyp€xz1z1?
V..1S zu1^ ?vzv€v1z1?

- » w..1uz1k^ tvz^ Ex1%€1gv..ttr~ ^ ^ Ex1.vtytv€1u^ .ty1Wz|v..1^ €u1^ sv..ttr} zEx^ Exv€1
- » ^ ^ ..1V..z z^ Ex1uv1^ ^ .. ttr} ttrv.. ~ v1^9 ?S?1w..1dty^ # vZ..zy^ Exv€1, uv..1^ ^ ..1R€} xv€>
r^ t}vx^ Ex: 1^ €u1
- » ^ ^ ..1Sv^ ..tvz^ Ex1uv..1dfr szűű1%€1d€ty... €~ r ttr} zExv€1?

R}}v..uzEx1z1t1uv..1Svx.zw^ ^ .. ttr} ttrvz^ Ex1^ €ttr} .w^ €u1uz1z1Szűű1C>B1xv' vz tv1^ , uv}}%..ttr}^ Ex1
z1t1€zty1€^ ..1ttr}..1%..vzv€vty1t, €uv..€1r^ ty1^ %€}}ttr}€uz=1t, 1ur ttr1uz1R€Sv€usr..1.vz1z- 1vZ^ v}w}}1
{vSvz1^ ^ 1yZ^ tv.wr.xv€1z1t1?

1

C?C|| d^., ~>1^ €u1dfr€€^ Ex1,, ^v}}v€1

Zuvr }v1d^., ~ >1^ €u1dfr€€^ Ex1,, ^v}}v€1^ €v..ttr}vzv€1ttr}1x...€u}vxv€u1%€vz€r €uv..?1Svzlvz€v..1zuvr >
>1^ €u1dfr€€^ Ex1,, ^v}}v1S p..x1uzv1dfr€€^ Ex1r^ ty1ur€€1z- ~ v..1tZ^ tw..z x=1Sv€€1gv.s.r^ tyv..1~ z1
vZv..1sv}zsvz1€zty1z€vr..v€1\ v€€}z1r Exv ttr}, ttrv€1S v..uv€1 1uz1_ zty1z€vr..z p1t. z1r^ ttr}zvù}zty1
z- 1d^., ~ 1r^ w1f ~ xv|vy..1S p..x1svzlvz€v..1zuvr }v1d^., ~ , ^v}}v1uv..1d^., ~ 1z- ~ v..1tZ^ tw..z x=1uzv1
yr1ur€€1^ ^ ..1W }xv=1ur ttr1_ zty1z€vr..z p1v€1vzv€1ttr} Exv ttr}, ttrv€v€1gv.s.r^ tyv..1r^ ttr}zvù}zty1z€1
uv..1dfr€€^ Ex1r^ v.vz€1S ..uv€1?

cvr }v1d^., ~ >1^ €u1dfr€€^ Ex1,, ^v}}v€1%..yr }trv€1ttr}1vz€v..tvz1S vxv€1uv..1uv€1b^ v}}v€1z€vS, y€v€>
uv€1Svx..v€^ ^ Exv€1^ €u1r €uv..x..tvz1S vxv€1xvS z1tv..1gv.yr }trv€1g, .xr sv€=1uz1u^ .ty1uz1cvxv}^ Ex1
uv..1f ~ .zty1v..1.vr }z1z..1S v..uv€1%€}}|, ~ ~ v€1r €uv..1r }t1zuvr }v1b^ v}}v€1?Uz1tv1g, .xr sv€1| €€v€1^ ?
S?1uz1z- f}v~ v€1z..€x1%€1b^ v}}v€1.vr | tr€^ v€1svz€yr }trv€1S z1t1z1z€1uv€1gUV>W_ 1R€ttr}^ ttr.v>
xv}€11 BAn1xvw..uv..1S v..uv€1?

1

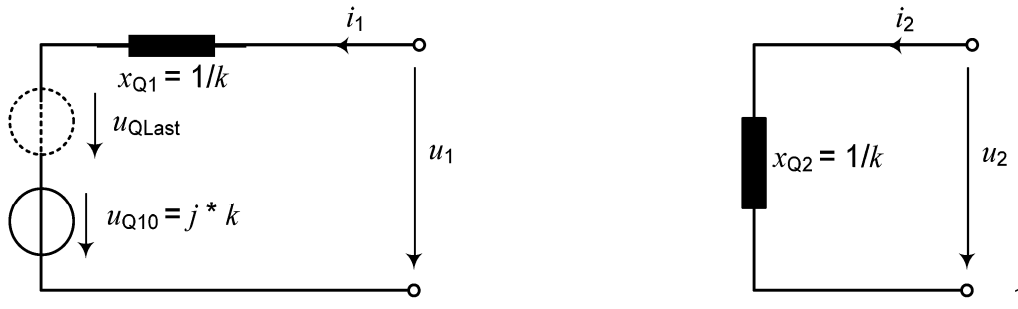

SzűűC>D1dfr €€^ €xt, ^ v}}v1- z1Z€€v€..xr | tr €' v€1z- 1- z1' €u1Xvxv€t€€tv ~ 1

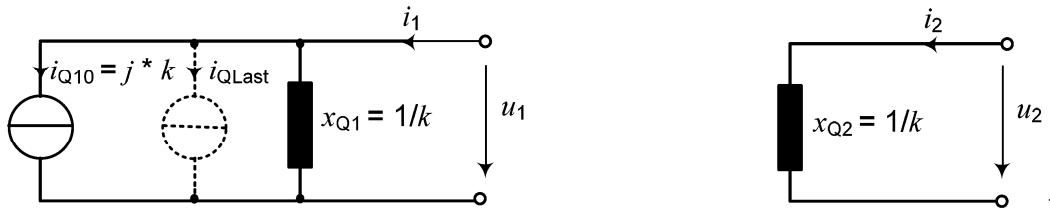

SzűűC>E1d±, ~ , ^ v}}v1- z1Z€€v€..xr | tr €' v€1z- 1^ z>1' €u1Xvxv€t€€tv ~ 1

Uzv1Sžuv..1C>D1' €u1C>E1' vxv€1vz€v1dfr €€^ €xt>1s' Š ?1d±, ~ , ^ v}}v1- z1Z€€v€..xr | tr €' v€1z- 1^ z>1' €u1 z- 1Xvxv€t€€tv ~ ?1Urt1gv.yr }tv€1svzv..1b ^ v}}v€1z1†1 1z€€v.yr }s1uv†1u ^ .ty1uz1cvxv} €x1.xr }z1z .tv€1 s' Š ?1.xr }z1z.sr .v€1Wv, ^ v€' sv.vzty†1 1sv' x}zty1b€uv..€xv€1uv..1} r†z- fvur €' 19 ^ ..tty} ††: 1%> |, ~ ~ v€1x}vzty?11

k ^ 1svr tytv€1z1†1w..€v. =1ur††1zty1x...üv1_v# v1- z1d±, ~ , ^ v}}v€1r €uv..1%..yr }tv€1r }†1vz€1vz€wtyv†1 ^ , uv}}1sv††yv€u1r ^ †1d±, ~ , ^ v}}v† €u1gv.s.r ^ tyv..1%..€ ^ tv€1}†††?1X...üv1_v# v1- z1d±, ~ , ^ v}}v€1 €vy ~ v€1z1z.y ~ 1..xr }v€1gv.yr }tv€1vz€1†fr €€^ €xt, ^ v}}v€>py€}ztyv†1gv.yr }tv€1r €?1Uv ^ }zty1Š zu1 uzv†=1S v€1S z.1' €†1vz€1r ^ †1d±, ~ , ^ v}}v€1xv†fvz†††1ösv..†.r x ^ €xt€v# 1- z1ur .r €1r €xv†ty}, †tv€v€1 Y, ty>1' €u1^ z1v}†fr €€^ €xt€v# v€1%..†tv}}v€?1Svzlvz€v ~ 1 ^ ..tty} ††1z€1vz€v ~ 1^ z1v}†fr €€^ €xt€v# 1 z1†1v†1%>}} , ~ ~ v€1^ €v.yvs}zty=1, s1ur††1ösv..†.r x ^ €xt€v# 1r ^ †1d±, ~ >1, uv..1dfr €€^ €xt, ^ v}}v€1xv > †fvz††1S zu1 1uz1tv..1\ ^ ..tty} ††1| r €1r ^ ty1S vzv.yz€1xr €' 1vz€wty1r }†1vz€1b ^ v}}v€†fr €€^ €x1' €u1 vz€v..1\ ^ ..tty} ††z- fvur €' 1sv†ty.zsv€1S v.uv€1ur 1uv..1\ ^ ..tty} †††±, ~ 1†, 1x ^ †1S zv1r ^ ††ty}zvü}zty1 u ^ .ty1uz1g, .z- fvur €' v€19€.r €†w... r † .v€† €u1}vz† €xv€: 1 ^ ~ 1ösv..†.r x ^ €xt€v# 1sv†z- ~ †1S zu1?11

1

C?D|| ` sv...†tyŠz€x ^ €xtsv}r†† ^ €x1 ^ €u1W}zt | v...1z ~ 1_ , ... ~ r}sv†...zvs1

Uzv1dfr €€^ €xt, ^ r}z1†1w..1_zuv..>1' €u1^ z1v}†fr €€^ €xt€v# v1z1†1z€1Uz_1V_1FABGA1%..xvxvsv€?1Uzv1 ur.r ^ †1' ^ }††z1v€1 dfr €€^ €xt%..tty ~ ^ # ^ €xt- x}zty|vzv€ 1Š.v.uv€1r ^ wuz1dfr €€^ €xtvsv€v€1 r ^ vxv†z1†=1S, svzlvz1Y yv1uv..1' ^ }††z1v€1 gv..tty ~ ^ # ^ €x 1z€1W... 1%€1' sv..†tyŠ z€x ^ €xt††±... v€1 {vŠ vz††1 ^ †v..1k ^ x...€uv}vx ^ €x1, szv..1 ^ , uv}}%..†tv}} €x19u?y?1 ^ €v..1Sv...t | ztyz x ^ €x1uv..1\ ^ ..> tty} ††}z1† €x1s' Š ?1uv..1ur .r ^ †1w}xv€uv€1\ ^ ..tty} ††.xr | tr €' 1k|=SzűűC>C: 1sv.vty€v†1S v.uv€† €u1 v€††f.vtyv€u1uv..1R€†ty} ††}z1† €x1uv..1R€†ty} ††€vy ~ v..1r ^ wuz1tv1r ^ vxv†z1†1S v.uv€?11

Uzv1^ , uv}}%..†tv}} €x1svzvzuz†1z€1- vy.wtyv..1Y z€†zty†1€zty?11

V..†tv€†1S zu1svzlvz..1R ^ wuz1' €x1r ^ wdfr €€^ €xtvsv€v€1€zty†1sv...t | ztyz x †=1ur††1uz1d ^ ~ ~ v1uv..1 }vz1† €xv€1uv..1_zuv..†fr €€^ €xt†.r €†w... r † .v€1r €1vz€v ~ 1^ z1v}†fr €€^ €xt€v# 1y yv..1z1†=1r }†1uz1 }vz1† €x1uv†1z€1ur††1^ z1v}†fr €€^ €xt€v# 1vz€†fvz†v€uv€1e.r €†w... r † .†1' €u1uz1d ^ ~ ~ v1uv..1}vz1 >

1

fr €xv€1uv..1^ zfv}tfr €€ €xtfr€tw... r t, .v€1r€1vz€v~ 1Y, tytfr €€ €xt€v t 1\$ zuv... 1x...uv...r}t1
uzv1uv..1ur t1Y, tytfr €€ €xt€v t 1r^ t1uv~ 1Y tytfr €€ €xt€v t 1tfvzv€uv€1e.r€tw... r t, .v€?Uzv1
%o.yr €uv€v1^ ..tly} tt}vz t€ x 1\$ zu1r}t, 1~ vy..wty1 %o.xvsv€ ?11

k\$ vzv€t1 t. zw1uzv1Zuvv1vz€v..1_v t, ^ v}v€z- fvur €' 1k | 1' \$ r..1~ z1x^ tv..1_pyv... €x1r^ wuz1X... €u>
tty\$ z€x^ €x1^ L1svzly yv.v€1Wv, ^ v€' v€1%o..trx t1taz1r sv...r1ur1\rf r' zpv€19€zv r t t%o.yr }t€: =1cv>
t, €r €' t t}v}v€1z- 1_v t 1' €u1f €tv..tly zuv1z- 1h z€ | v}1uv..1dfr €€ €x19svz1' sv..tly\$ z€x^ €xv€=1uzv1vz€v1
wt t v layr tv€}rxv1^ ..1dfr €€ €x1yr sv€: 1€zy t1sv... t | tzy t z t1\$ v..uv€19| €€v€: ?1

f €u1U.. zfv€t1 t. zw1uzv1g, ..t t}v} €x1vz€v..1 t. v€x1 t z€^ tw... z v€1a, }.rutfr €€ €x=1r^ t1uv..1uv..1^ ..>
tly} t t1uv..1' sv..tly\$ z€x^ €x t t... ~ v1y z€ tv..1uv..1b^ v}v€z- fvur €' 19\$ zu1C>C: 1r svx}v z v t1\$ zu=1r^ w
^ ~ ..zty tv..sr t z v 1V...v^ x^ €x tv z€yv z v€1 t, 1€zy t1' ^ ?Ur 19€ 1C: 1V...v^ x^ €x tv z€yv z v€1 x v€^ t, 1\$ z v1
gv..s.r^ tyv..1r}t1 b^ v}v€ 1%€1' sv..tly\$ z€x^ €x t t... ~ v€1sv t.rty t t1\$ v..uv€=1wy}v€1z€1vz€v~ 1'^ >
| €v z v€1_v t 1, y€v19, uv..1~ z1\$ v€z: 1d€ty... €~ r tly z€v€1uzv1 dv€|v€ 1w..1uzv1' sv..tly\$ z€>
x^ €x t t... ~ v?

V t1| r €€1r}t, 1w t t x v t t}v}t1\$ v..uv€=1ur t t1uzv1V... z t} €x1uv..1 gv..tly~ ^ t^ €x t..vty t v 1r^ t1uv..1^ ..>
tly} t t}vz t €x1^ €u1uv..v€1gv..t z} €x1r^ wuzv1R€tly} t t€vy~ v..1' \$ r..1r^ t1dzty t1uv..1eyv, .z v1€zy t1
%o}t t p€uz1 svwz uzv€1 | r €€1 1r sv..1v t1 x z t1 uv...v z t | v z€v€1 sv t tv..v€1^ €u1v z€w tyv..v€1R€ t r t ?11
R^ ty 1\$ v€€1 t1€zy t R^ w r sv 1uzv t v t1R..sv z t fr | v t t t z t v z€v1R sv r €u} €x1 sv..1' sv..tly\$ z€x^ €xv€1^ 1
tly..v z v€=1 t, }1u, ty1ur..r^ w y z€xv \$ z tv€1\$ v..uv€=1ur t t1ur t1eyv~ r1' sv..tly\$ z€x^ €xv€1w..1uzv1k^ >
| ^ €w1svur ty t1\$ v..uv€1~ ^ t t?Uzv1' sv..tly\$ z€x^ €xv€1y yv..v..1' .u€^ €x1| €€v€1 t zty1 sv..1uzv1b^ v.>
| r fr' zpv€1z- 1_v t 1 tly} z v€v€L1' ^ €vy~ v€uv1gv..|rsv} €x1~ r x1uzv t1v..j z ty t v..€?1W ..1uzv1' sv..>
tly\$ z€x^ €xv€1€zu..xv..v..1' .u€^ €x1~ t tv€1dv€|v€1xv w€uv€1\$ v..uv€?1_r ty1uv..v z1r s tyv sr..v€1
V€ t \$ z | } €x1\$ v..uv€1uzv t v1R^ w r sv€1%€1f ~ ..zty tv..€1 sv..€, ~ ~ v€1\$ v..uv€1~ t tv€L1u?y?1uzv1f ~ >
..zty tv..1~ t tv€1^ | €w z 1€1uv..1] r x v1 tv z€=1w..1' sv..tly\$ z€x^ €xv€1€zu..xv..v..1' .u€^ €x1r}t1 dv€|v 1
' ^ 1\$ z..v€?1g, .t z y r w t z t =1\$ v€€1uzv t v1 dv€|v 1\$ z v1v€1, y~ t tyv..1h zuv..t t €u1\$ z..| ?1Ur w..1~ ^ t t1uv..1
f ~ ..zty tv..1r^ w z€v1€v t tv z v1' sv..tly\$ z€x^ €x1uv..r..t1.vr x z v..v€=1ur t t1v..1v z€v€1' sv..tly\$ z€x^ €x t >
t t... ~ 1~ z1uv..tv}sv€1Wv, ^ v€' 1' €u1ayr tv€}rxv1\$ z v1uzv1' sv..tly\$ z€x^ €x t t fr €€ €x1r^ w z~ ~ t r}t, 1
sv' x} z ty1uzv t v..1Wv, ^ v€' 1\$ z v1v€1, y~ t tyv..1gv..s.r^ tyv..1\$ z..| ?1Uzv t v1h z..|}vz t €x1\$ zu1€zty t1z€1
h p... v1~ xv tv t t, €uv..€1z- 1k \$ z tyv€|..v z t1uv t1f ~ ..zty tv..t1xv t f v z tyv..t1' €u1z€1uv..1X... €u t ty \$ z€>
x^ €x1r}t1 ^ vy..j z t €x 19svz1V...v^ x^ €x t r €}rxv€: 1s' \$?1 ^ z€uv..%o..s.r^ ty 19svz1' ~ ..zty tv..xv t t v^ v.>
t v€1gv..s.r^ tyv..€: 1 t z y t s r... ?1

Vz€1uv..r..t z v t1gv..yr }t€1 | r €€1svz1f ~ ..zty tv..€=1uzv1~ z1vz€v..1a^ }t\$ vzv€~ , u^ } r z €1r..sv z v€=1u^ ..ty1
xv v z €v t v1cv xv} r x, .zty ~ v€1.vr }t z v..t1\$ v..uv€?1g, .r^ t t v t^ €x1ur w..1z t t=1ur t t1uzv1~ z€z- r }v1er | t r..t v1
uv t1f ~ ..zty tv..t1' ~ 1v z€v€1r^ t..v z ty v€uv€1W | t, .19%o... ^ t z ty1OE: 1y yv..1r}t1uzv1' ^ 1svv z€w t t v€uv1
' sv..tly\$ z€x^ €x1z t t?Z- 1Xv xv€ t r t 1ur^ ^ 1yr sv€1f ~ ..zty tv..1~ z1^ ^ }t z}v%o>evty€, }, x z v1x... €u t p t >
} z ty1v z€1z€yp..v€ t t1dfr €€ €x t, ^ v}v€%o.yr }t€1' €u1| €€ t v€1svz1v z€v..1v€ t f v..vtyv€uv€1cv xv} €x1z- 1
X... €uv1xv€, ~ ~ v€1r^ w sv..tly\$ z€x^ €xv€1\$ z v1v€v1a, }.rutfr €€ €x1\$ z..v€?1

Uv t z t1sv' x} z ty1^ ^ }t z}v%o>f ~ ..zty tv..t z y v1R€yr €x t t ?11

1

1

1

C?E|| \ ^ ' tty}^ tttt... , ~1

dtv^ # v€ . zty# €xv€1\$ v. #v€1w. .1uv€1\ ^ . . . tty} tttty^ # 1uzv1X . . . €utty\$ z€x^ €x1uv†1\ ^ . . . tty} tttt... >
 ~ vt†t, \$ zv1xxvWuzv1X . . . €utty\$ z€x^ €x1uv. .1dfr €€^ €x1r ~ 1(v\$ v\$zv€1cv)r ztvz€sr^ , . . . †r^†1†dty^ # v€ >
 . zty# €xv€=1uzv1' ^ ~ 1V. w}}v€1zy. . . .1dty^ # w€| †z €1y yv. .x1Wv, ^ v€' v€1r}†1uzv1X . . . €utty\$ z€x^ €x1
 sv€ †zv€1>1' ?S?1V. utty} ††\$ ztyv. . . .v}r z†1' €u1h r €uv. . \$ v}}v€ty^ # 1>1\$ v. uv€1z€1uzv tv ~ 1Sv. zty††€zty†
 sv.†. rty†v†?1Uzv1^ , uv}}% . . . ††v}}^ €x1xv ~ ?1Szu1C>B1. . . . ztyv€1w. . . .1vz€v1X . . . €utty\$ z€x^ €x1sv.†. rty# €x1
 %o}} , ~ ~ v€1r^†?1k^ 1svr ty†v€1z††1{vu, ty=1ur††1uzv1b^ v}}v€†fr €€^ €xv€1z- 1c t| v€1uv. .1cv}r z†1| vz€v1
 ' ^ 1^ €†v. . . . ttyzv}ztyv€1h z€| v}1' ^ vz€r €uv. . . .1yr sv€1u . . . w€?1Z€1vz€v ~ 1_v# =1z€1uv ~ 1svz1vz€v ~ 1\ ^ . . . >
 tty} ††1uzv1b^ v}}v€†fr €€^ €x1uv. .1V. . . .v^ x^ €x†r €r} xv€1sv}zsvz1h z€| v}1' ^ vz€r €uv. .1r €€vy ~ v€1\$. . . >
 uv€=1xpsv1†1z- 1\ ^ . . . tty} ††w}}1| vz€v€1†z€€%o}}1r^†\$ v. . . . †r. . . .v€1d†. . . . ~ 1 1vz€v1xv\$ z††v1 e. . . .pxyvz† 1uv. .1
 b^ v}}v€†fr €€^ €xv€1s' \$?1 ††. . . . ~ v†z††r}†, †z- ~ v. . . .1v. w. uv. . . .}zty?

Ur ~ †svz1dty^ # v€ . zty# €xv€1svz1sv†, €uv. .v€1_v# ' ^ ††p€uv€1| vz€v1ösv. w€| †z €1††††w€uv†=1sv€ >
 †zv€1uzv1cv}r z†1r^†uv. .1uv. .1X . . . €utty\$ z€x^ €x1r^†ty1Z€w. . . . r †z €v€1 sv. .1r €uv. .x1g, . . . xp€xv1z- 1_v# =1
 uzv1†z1z€1uv. .1cvxv}1r^††vz€v. .1R€r }€†v1uv†† sv. . . . tty\$ z€x^ €x††fv| †. . . ~ †1uv. .1d†. . . ~ v1v. yr}†v€?1Svz
 †fzv}1yzv. w. .1†z€u1uzv1C?1Yr . . . , €ztyv1' ^ ~ 1d†r sz†z v. v€1uv†1Uzww. v€†z}†ty^ # v†1svz1Vz€†tyr}†%o. >
 xp€xv€1vz€v†1e. r. €†w. . . . r †. . . . ††^ €u1uzv1F?1Yr . . . , €ztyv1' ^ . . .1V. . . .|v€€^ €x1%€1e. r. €†w. . . . r †. . . . ††z^ € >
 xv€?1R^ ty1uzv1v1Wv, ^ v€' v€1- ††v€1w. .1ur†1cv}r z†1†, \$, y}1z- †^ €xv†† . . . v€1Sv†. zsv1r sv. .1z- 1Sv†, € >
 uv. .v€1r^†ty1z- 1\ ^ . . . tty} ††w}}1 ^ €% . . . w}}†ty† 1' ^ . . .1gv. wx^ €x1††vyv€L1u?†1z1~ ††v€1uv€1 €r † . . . }z
 tyv€ 1fy€†z††ztyv€1g, . . . xp€xv1z- 1_v# =1v€††f. vtyv€19y. . . %o. xv. . . . w€1u^ . . . ty1Z€u^ | †z€††v€=1r fr' †p >
 †v€=1d††z^ €x†| v€€}z€v€1%€1e. r. €†w. . . . r †. . . . v€1v†?†^ €u1u . . . w€1u^ . . . ty1cvr | †z €v€1%€1f ~ . . . zty†v. €1
 €zty†††, 1% . . . w}}†ty†1\$ v. uv€=1ur††1uzv1 €r † . . . }ztyv€1g, . . . xp€xv 1%o ~ 1dty^ # 1€zty†1- vy. .1†ztyv. .1r^†xv >
 \$ v. #v†1\$ v. uv€1| €€v€?

1

C?F|| d†rsz}z††1% , €1d€€ty... , € ~ r†tyz€v€1

Z€1_v# r €†ty} ††svuz€x^ €xv€11Fn1\$ zu1w. .1| , €%€†z €v}}v1\ . r. w\$ v. . . .|v1xvw. uv. †=1ur††1uzv1v1€r ty1
 vz€v ~ 1u. vzf, }zv€1Wvy}v. .1††rsz}svz€v1- ††v€=††, }r €xv1uzv1svuz€x^ €x1

1 G fl_ -1 1 1 1 1 1 1 9X}†1C>D: 1

v. w}}††z††?1Ursvz1svuv^ †v†† G uzv1€r ty1uv ~ 1Wvy}v. .1€v# †vz†z1r €††vyv€uv1R€w€x†| ^ . . . tty} ††\$ vty >
 tv}††. . . }z††^ €x1xv ~ pü1uv. .1^ , uv}}% . . . ††v}}^ €x1z€1Szu1C>B1^ €u1ax€1uzv1_v# €€\$ z. | }z††^ €x1uv. .1V. . . .v^ >
 x^ €x†vz€v†v€1r €1uzv tv ~ 1_v# r €†ty} ††f^ €| †?

R}}v. uz€x†1xvy†1uzv tv1W . uv. . . . €x1%€1vz€v. .1g, . . . r^††v# ^ €x1r^††=uzv1' ^ . . .1kvz†1uv. .1V. . . .††v}}^ €x1uv. .1R€ >
 tty} ††. zty†z€v1€, ty1†v}†††% . . . ††p€u}zty1\$ r. .1^ €u1uryv. .1€zty††v. . \$ py€†1\$ ^ . . . uv1^ €u1uzv1uv ~ 1^ , uv}}1
 €zty††r €^††vyv€1z††=€p ~ }zty†vz€v. .1v€††f. vtyv€u1††rsz}v€1b^ v}}v€†fr €€^ €x1 1r}†, 1vz€v. .1†vy. .1y, yv€1
 †. pxv€1^††††v€=1uzv1†zty†† €†zty†sr. .1y z€†v. .1uzv tv. .1b^ v}}v€†fr €€^ €x1% . . . szx†?

1

D1 X...v€‘v€1uv...1V ~ fwz€u}zty | vz†1%, €1d ty ^ †‘ vz€...zty† ^ €xv€1

D?B|| Uz††r€‘†ty ^ †‘1

D?B?B| ^ z€uv†††... , ~ vz€††v} ^ €x1

Uz††r€‘ .v}r z†1 z- 1 Y ty†††fr€€^ €xt€v† 1 Šv.uv€1 yv^ †v1 z€1 uv..1 cvxv}1 ~ z†1 vz€v..11 Z- fvr€‘ r€..vx^ €x1svz.zsv€=††, 1ur††1uz1V~ fwz€u}zty | vz†1uv††^ v††f.z€‘ z†1}vuz }zty1u^ .ty1uv€19~ 1 cv}r z†1vz€††v}sr.v€: 1^ z€uv††††... ~ 1svx.v€‘ †z††?

k^ 1sv...t | †zty †zv€1†z€u1uzv1svz1}vz† €xv€1†ty, €1z- 1_... r}svz.zsv1r^ v.v†v€uv€1f €†€- ~ v†.zv> ††... vL1svz1vz€v- 1}r††††... ~ 1%€1E?AAAR1^ €u1vz€v..1^ €%u.z}†v€1}vz† €x1| r€€1uv..1D; ZA>d†... ~ 1vz> €v†1d€††v- †1svz†fz}†Š vz†v1sz†1^ 1DAAR1sv†.rxv€?1Uv..1R€†f.vtyŠ v..†1uv..1V.u††... ~ v..w††^ €x1ZvO1 ~ ^††1r^ w{vuv€1W}}ly yv..1vz€xv††v}††Š v.uv€=†r}†1uz†v..1f €†€- ~ v†.zv††... =†ur1vz€v1Vz€††v}€ x=† uz1w..1}vz†v..1W}v..1v~ fwz€u}ztyv..1z††r}†1w..1}vz†v..1uv1W}v..1€zty†1}zv}wy..x€1z††?Uz††v..1 V.u††... ~ 1svx.v€‘ †1r}xv~ vz€1uz1V~ fwz€u}zty | vz†1uv..1Z- fvr€‘ r€..vx^ €x1^ €u1uv..1Uz††r€‘ ~ v††^ €x11 uv..1cv}r z††?

Uv..1vz†1.vr}z†v..1v~ fwz€u}zty vz†1	CEAR1 1GAAR1
cvr}z†v..sr.v1V~ fwz€u}zty vz†1 11 }vz†^ €x ty, ty1sv}r††††† €u† €%u.z}††1	EAAR1 1GAAR1
cvr}z†v..sr.v1V~ fwz€u}zty vz†1svz1vz€v..1x^ †1%u.z}†v€1}vz†^ €x1	BCAR1 1CAAR1

1

D?B?C| Srt | ^ f>W^ €|z, €1f€rsyp€xxzv...1ösv...††... , ~ ‘vz††ty ^ †‘19Sf ` T:1

Z€1%zv}v€1W}v€1S zu1z- 1Uz††r€‘ t†y^ † 1vz€††, xv€r€€†v..1, †f^ k1dty^ † 1f...{v | †z..†?Uz††v..1r | †z%w..†1 †zty1^ Š?1svz1W}v..€1z- 1dfr€€^ €xtŠr€u}v..1.vz†1, uv..1svz1††r..11%..1v...†v€1dfr€€^ €xt†z€r}v€=† Šv€€1uz1Uz††r€‘ t†y^ † w€|z €1€zty†1- vy..1. u€^ €xtxv~ pü1w€|z €zv..†?Uz††1^ 1.vr}z†v..x€uv1V~ f> wz€u}zty | vz†1uv..1, †f^ k1W €|z €1z††1€^ ..1%~ 1r^ v.v†v€uv€1^ ..1†ty}††††... ~ 1rsyp€xz=†^ €u1†, ~ z†1 r^ ††ty}zv}zty1%€1uv..1Z- fvr€‘ 1uv..1}vz†^ €x1^ €u1uv..1^ ..1†ty}††}vz††^ €x1r~ 1Vz€r^ , .†?1svz1.vu^ > ‘zv..1v..1^ ..1†ty}††}vz††^ €x1| r€€1uz11€, †Šv€uzv1V~ fwz€u}zty | vz†1xvzvsv€v€w}†1€zty†1- vy..1.vr}z- †z..†Šv.uv€=†, y€v1uz1ösv..†.rx^ €xt}vz††^ €x1uv..1}vz†^ €x1vz€^ ^ t†y.p€|v€? 1111

1

D?B?D| Vz€w} ^ †††xv.z€xv...v..1^ ^ ... ‘†ty} ^ ††††... ~ v1r^ wuzv1cv†z††r€‘ vz€††v} ^ €x1%, €1Uz††r€‘ ...v}rz††1

Uv..19z€1v..1†v..1_ pyv...€x: 1, y~ t†y1v1h zv..††r€u1vz€v††}zty†s, xv€†1z††1r^ üv..1%€1uv††v€1}p€xv1%o..1 r}v~ 1%o~ 1^ ^ ..1†ty}††††... ~ 1rsyp€xz?1R€xv}vy€††r€1Gn† €u1z€1Hn1v.xvsv€††zty1w..1uz1cv†z††r€‘ > vz€††v}€ xv€1w}xv€uv1^ z€uv††Š v..1v1w..1uz1}zty†s, xv€..v†v..%o19g, ..1^ xtŠv..1v1†z€u1^ €†v..††.ztyv€: K

1

D?k, €v1	1BE>B1.1 f.z- 1
R€..vx^ €x1	1CG>DA1 f.z- 1

1

1

Vt1tvzlvur .r. ^ wlyæxvš z/vtve=1ur tt1u ^ .tyr ^ t1Wvyjv .1r ^ w.v.tve=1uzv1uvE1t, vsvE1w. ~ ^ }zv .tvE1crEusv > uæx ^ ExvE1Ezty1xvE xve=1svztfzv}tšvztlösv..tty}pxv1%oE1væv~ 1]vzv..tvzj1 ^ 1væv~ 1Sr ^ ~ 1æ1uv..1 ^ ztv1' Š ztyvE1C1^ r ttvE1r ^ w...Eu1u ^ .tyypEexvEu..1]vzv..tvzv?1Uv..lyzv.svzlr ^ w.v.tveuv1cvr }tvz1uv..1 \ ^ ..tty} ttz- fvurE' zt1.væ1tfv| ^ }r t%b 1v..1| rE€1Eryv ^ 1sv}zvsz 1x...ù1tvæ1' Eu1vE# zvy1ttzy1{vx} > tyv..1%..E Ewzv..1Rsttyp# ^ Ex?1ZE1uzv1vE1Vp}jvE1y}zv1vzvE1}zty1E ^ .=1uvE1cvttzrE' Š v.1uv..1Z- fv > urE' rE.vx ^ Ex1t, 1y, ty1Š zv1- x}zty1væ ^ ttv}jvE19}t, 1svztfzv}tšvztlrE1uzv1, sv.v1X.vE' v1%oE1%o.> rEttvylvEu..1ersv}jv: 1^ Eu@ uv..1vævE1' ^ tp# ztyvE1tfv' zv}jvE1dty ^ # 1w..1V.uwyjv.=1svztfzv}tšvztlv 1 væv1df c>W|E| z E1, uv..1vævE1V.uwyjv...zty# Ext%b.x}zty1 ^ 1r | t%b.vE?11 1

h vE€1uv..1 .}ztyv1UztrE' tty ^ # 1vævE1y, ty, y- zvE1V.uwyjv..1Ezty1v..|vE€E1| rE€=1S zu1uv..1, .}t > w..E1cv1v..%tt ^ # 1- z1y, yv..1h ry..ttvæ}zty|vz1r ^ ty1Ezty1.vr xv.vE1| E€E?1Uv.r..}zv1Wvyjv..1 Š v.uvE1{vu, ty1%o~ 1]vz# Ex1uzw.vE}t}ty ^ # 1v.wtt?1d, }jv1uzv1v..1%b.trxvE=1S zu1ttzy1uv..1væf, } > xv1Wvyjv..1Er ty1væzv..1kvz1u ^ .ty1uzv1r ^ w}zvzvEuE1yvzvE1Xr tv1uv1t] ztyts, xvE1t' ^ 1væv~ 1- vy.> f, }zvE1Wvyjv..1vE1S z|v}E=1uv..1%o~ 1UztrE' tty ^ # 1r ^ w{vuvE1W }jv..|rE€1S v.uvE1| rE€?11

h vE€1r ^ ty1w..1y, ty, y- zv1væf, }zv1Wvyjv..1væv1dty ^ # .vu ^ EurE' 1%o.yrEuE1tvæ1t, }=1zt1væv1 tvfr.r.tV.u| ^ ..tty} tttty ^ # wE| z E1 ^ 1.vr }zv.vE?1

1

D?C|| V...u>\ ^ ...' tty} ^ tttty ^ # '1

D?C?B! R}}xv ~ vzEvt

k' ?1S v.uvE1v~ fvæEu}ztyv1V.u| ^ ..tty} tttty ^ # wE| z E1vE1æ1Uv ^ tty}rEu1Ezty1v}ptyvEuvt| vE1væ > xv1v# ?1

dty ^ # væ.zty# ExvE=1uzv1tfv' zv}jw..1V.uwyjv..1r ^ txv}x1ttæu=1S v.tve1f.r.| zt1ty1z- ~ v..1uzv1_ ^ }tE > tv~ x...ùvE1r ^ t?1Uv 1æ1uv..1cvxv}1| væv1Z- fvurE' 1svttz- ~ 1S zu=1ttæu1tzv1y zv..1tvfr.r.r1r ^ wvwvy.#1 r ^ ty1S vE€1zy.v1W E| z E1æ1væv~ 1UztrE' .x}r z1.vr }zv.#1S v.uvE1| rE€L1ur svzlr..svzv1uv..1V.u| ^ ..> tty} tttty ^ # 1fr.r.}jv}tEuT ErsypEzx1%o~ 1UztrE' tty ^ # 1

Z- 1XvxvEtr # 1' ^ 1 ^ ..tty} ttvE1' Š ztyvE1C1, uv..1- vy..1]vzv.E1| rE€1svzlvæv~ 11V.u| ^ ..tty} tt1{v1 Ertv1Wvyjv..|, E1tv}r z E1uv..1.vttz%1RE}zv1uv1t\ ^ ..tty} ttfwuv1ttvy..1y, ty1tvæ=1svztfzv}tšvztlv 1 urE€=1S vE€1væ1Sr ^ ~ 1æ1uv..1^ ztv1væv1t1dfrE€w}jv1tæ1uzv1]vz# Ex1S ptytt=1væ1^ r tt1vævE1y, yvE1 V.u ^ Ex1S zv..}trEu1svttz# 1^ Eu@ uv..1uzv1xv, }, xz1tyvE1gv.yb}tEz1tv1ttty}ty1ttæu19W}t=1#..t| vE..1 drEus, uvE1v# ?1Uz1v1Wvyjv..1| E€E1svzlvæv..1Væ1tv}# Ex1uv..1RE.vxv.vttzrE' 1r ^ wuv..1c>Rtytv=1 Š zv1tzv1w..1y, tysv}r ttv1v1]vz# ExvE1v.w.uv..}zty1zt1=1%oE1uv..1RE.vx ^ Ex1uv1UztrE' tty ^ # vt1Ezty1 v..|rE€1t' Eu1æw}xvuvttvE1r ^ ty1Ezty1r sxv1tyr }tv1S v.uvE1?11

Uzv1V~ fvæEu}zty|vz1%oE1V.uwyjv..tty ^ # væ.zty# ExvE1zt1u ^ .ty1uzv1Er # .}ztyv1fE1E- ~ v.t.z1z- 1_v# 1 svx.vE' t=1uzv1ttzy1%o..1r }jv~ 1z- 1_ ^ }tE}tv~ 1' vz1?1Uz1fE1E- ~ v.t.z1t...~ v1^ Eu1 tfrE€ ^ ExvE1ttæu1 Š v.uvE1S vtvE1}zty1u ^ .ty1uzv1fE1E- ~ v.t.zv1uv..1cvr | trE' vE1uv..1]vz# ExvE1' Eu1u ^ .ty1uzv1Y yv1uv1t]r ttt#..~ vt1svttz- ~ ?1W ..1uvE1Vætr # 1væv1v~ fvæEu}ztyvE1V.u| ^ ..tty} tttty ^ # vt1x}t#1

Y, yv1r ttt#...~ v1v.w.uv.E1væv1k ^ tv1gv.u.z}# Ex1uv..1]vz# ExvE?1

1

1

1

D?C?C! Xv...ztyfv...1Z%v...tv...l_ ^}}tf r€€^ €xt' vz|t ty^†'† 1V\ f ck d f c1

Ur†1cv}r z†1.vx†1r €=1Š v€€1†, Š, y)1uz1V.ut†r €€^ €x1f_v1r}†1r^† ty1uv.1V.ut†.,~ ††.,~ 1Z1vZ€v1vZ€xv>
††v}}†v€1dtyŠv}}Šv.†1 sv..†ty.vz†v€=1^ €u1††r .†v†1ur†1kvz†x}zv1†r€..?1_r ty1Rs)r^ v%€1†r€..1Š zu1vZ€v1
f_v>r syb€xzxv1Z€%..†' vz| v€€}Z€z1†r 9f_v: 1xv††r .†v†1[v1Er ty1czy† €xtv€††tyzv1 f_v@v1} ††1ur†1
cv}r z†1Er ty1Rs)r^ vuv..1Z€%..†' vz| v€€}Z€z1r^†19svzlczy† €x1%o.Š p.†: 1, uv..1wx†1€, ty1vZ€v1^†p† }>
tyv1kvz†%..! xv...€x††p1yZ€^†1 €u†} ††1ur €€1r^††1

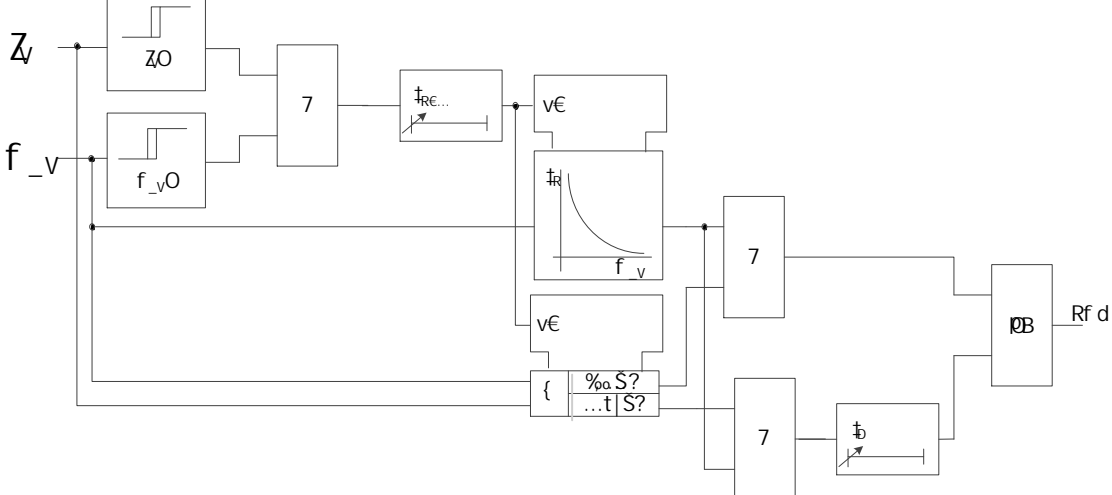

1

Szu1D>B1W €| †z €1df c>cv}r z†19V\ f ck: 1

1

V\ f ck 1r }†1 . .††w..€v..1cv†v..%o†ty^† K11

h v€€1| vZ€1dtyr}†v..%o..†rxv..†ty^† 1v< z††z .†† €u1vZ€1dtyr}†v..%o..†rxv€19Š v}tyv†1Z€1uv€1Y ty†††f r €>
€^ €xtvsv€1Z€1uv..1cvxv}†vZ€f, }x††vZ€1Š zu: 1%o€1uv€1, .††w..€v€1dty^† vZ€.z†† €xv€1..†r €€†1Š v.uv€1
~ ^††=z†††vZ€1†vy..1v~ f_v€u}z††y1VZ€††v}} €x1v.w.uv.}z††?1Uz1Xv†r~ †r^††} †v' vz|†}zv†1ur svz1uv^†z††y1
sv..1uv..1_v† v€u' vZ€1uv..1Uz†† €' .v}r z†11

1 Zv0 1N 1A=AF; Z€1N 1GA1 1BFAR lz- 1DI A>| g>_v† 1 9Z€1N 1h r €u}v..€v€€††.,~ : 1

1 f_v0 1N 1A=ADF; f_€@D1 1 1 Y Z€Š vz†K1f_v1z†††y zv..1uv€†††ty1~ z††f_†1

1 †r€..1N 1C=F†1

1 †p1N 1D=F†1

ösv...vr | †z €v€1s' Š?Wvy)r^††} †^ €xv€1†Z€u†.,† 1uv..††vy..1v~ f_v€u}z††y1VZ€††v}} €x1€z†††sv | r €€††?

1

1

1

V\ f ck 1r }t1 . }zt yv . 1cv tv . %& t ty ^ # 1

Svz1Vz€tr # 1uv . 1V\ f ck >W €| z €1r }t1 . }zt yv €1cv tv . %& t ty ^ # 1z t1 }vuz }zt y1vz€v1€zty }tr ^ t . vzt yv €uv1 R€ . xxv . vzt yS vzv1uv t1Uz t# €' t ty ^ # v t1svz1W y }v . €1r ^ vuv ~ 1vzv €v €1 }vz €' Ex t t €t v ~ 1 ^ | , ~ fv €t zv > . v €?1Uz1Vz€t v }# €' Ex 1w . 1uv €1V . ut t# . ~ 1| r €€1ur yv . 1 €v ~ fv €u }zt yv . 1xv S }t1S v . uv €=svz t f z }t S vzt v K1

1 Z_vo 1N 1EAAR1z- 1DI A>| g>_v# 1

Uz v1v . w . uv . }zt yv1Vz€t v }# €' Ex 1w . 1uz v1V . ut f r €€' Ex 1yp €x t1z €1t # . . | v ~ 1 ^ r üv 11% €1uv €1b ^ v }v €z- fv > ur €' v €1 ^ €u1z€tsvt , €uv . v1r ^ ty 1% €1uv ~ 1gv . y }# €z t1uv . 1b ^ v }v €1 ^ z > 1 ^ . 1 _ ^ }z- fvur €' 1rs ?1Vz€v1 v ~ fv €u }zt yv1Vz€t v }# €' Ex 1w . 1f A O t z t1ur yv . 1r ^ ty 1w . 1uv €1 . }zt yv €1V . u | ^ . . t ty } t t t ty ^ # 1v . w . uv . }zt y?

1 f _vo 1N 1A=ADF; f €@ D1

Vz€v1R€ . xxv' v z t1# r € . 1 , sv . yr }s 1uv . 1Rh V > ar ^ tv €' v z t1# r €' z t y 1B t : 1z t1' S z€xv €u1v . w . uv . }zt y = 1ur ~ z t1ur t1 cv }r z t1€zty t1S }v €u1uv . 1Rh V > ar ^ tv €' v z t1r ^ t } t # ?

dv | t z € t1 ^ 1r €uv . v €1d ty ^ # v z € . z ty # €xv €1

Uz v1dv | t z € t1uv t1V\ f ck 1' ^ 1r €uv . v €1d ty ^ # v z € . z ty # €xv €1z t1u ^ . ty 1uz1Vz€t v }# €' Ex 1uv . 1R ^ t } tv > ' v z t1 , sv . yr }s 1uv . 1_v # v €u' v z t1z ~ v . 1xv S }v }z t v }# ? 1f ~ xv | vy . 1x z t1uz v t v1R ^ t t r xv1€zty }k1uv . 1Uz > # €' t ty ^ # 1% €1e . r €t w . . r # . v €1S z u1z €1uv . 1cv xv }z- 1| r t t sv . v z y 1r ^ vuv €1tr ?1C > w ty v €1_v €€t # . ~ 1 v z €xv t v }# }t S v z ty , ty > sv }r t v # €1 }v z €' Ex v €1~ z t1v €t f . v ty v €u1' €v ~ fv €u }zt yv . 1c > v z ty S v z v1S v . uv €1 tv y . 1y , ty , y ~ z v1 }v z v . > v . uv > ^ . . t ty } t t v1€zty }t1% ~ 1Uz t # €' t ty ^ # 1r sxv t t y }v # t t , €uv . €1>1S v €€1 | v z €1 }v z €' Ex t uz w . v €t # }t ty ^ # 1% . yr €uv €1z t1 1' v z % . . x v . # 1 % ~ 1V . u | ^ . . t ty } t t t ty ^ # ? 1Urs v z | r €€1v z €v1W y }r ^ t } t ^ Ex 1€r yv }z xv €uv . 1e . r €t w . . r # . v €1r ^ v v t v €= 1ur 1uz v t v1S v xv €1z y . v . 1v ~ fv €u }z > ty v . 1v z €xv t v }# }v €1R€ . vx ^ Ex 1uv €1y , ty , y ~ z v €1W y }v . 1v . | v €€v €1 | €€v €1' €u1z €1V €u' v z t1r ^ t } tv €? 11

1

D?C?D! V...uwy}v...>czty#^Ex t %v...x}vzty!

Uv . 1V . uwy }v . > czty # Ex t % . x }v z ty t t ty ^ # 1sv t }v }t f . z €' z f z }# 1r ^ t1v z €v . 1f A @ A > czty # Ex t sv t t z - ~ ^ Ex 1 uz v1 ~ z t1v z €v . 1f ^ k > W €| z €19w t }v1kv z % . . x v . . €x : 1s' S ?1R ^ k > W €| z €19% ~ 1d # . . ~ 1rs y b Ex z v1 kv z % . . x v . . €x : 1z- 1d # . . ~ > ^ }t €t v ~ 1| , ~ s z €v . # t S z u ?

Uv . 1V . uwy }v . > czty # Ex t % . x }v z ty | r €€1 ~ z t1u z % . tv €1d z €r }% . x }v z ty t % . w y . v €1r . sv z v €= 1v t t t €u1 t , S , y }1w z v sv €uv1r }t1r ^ ty 1s } , t | z v . v €uv1gv . w y . v €1 ~ x }z ty = 1v sv €t , 1v z €v1# . r €t z v €t v1S } , t | z v . . €x 1 sv z1W y }v . S v ty tv }? 1Ur t1gv . w y . v €1r . sv z v # t t # . v €x 1v }v | t z % 1 sv € t z t1r sv . 1v z €v1_r ty . z ty v €% . > s z €u ^ €x ?

R ^ t } t ^ Ex v €1z €1d ty €v }# }v z t1' €u1Rh V1t z €u1 . vr }z v . sr . ?1Uz v1W €| z €1V . uwy }v . > czty # Ex t % . x }v z ty | r €€1tv y . 1v ~ fv €u }zt y1v z €xv t v }# }t S v . uv €?1V . 1| r €€1sv z1R€ . vx ^ Ex 1uv . 1Uz t # €' t ty ^ # > Y r ^ f t w €| z €1 s } , t | z v . # t S v . uv €? 11

Sv z t v y . 1y , ty , y ~ z v €1W y }v . €= 1v z €v . 1v ~ fv €u }zt yv €1Vz€t v }# €' Ex 1' €u1v z €v . 1y , yv €1Sv }r t t ^ Ex 1uv t1f r > . r }v }v €1d # . . ~ | . v z v t t t z €u1W y }v €| z €v €1 ~ x }z ty ?1Uz v t v1S v . uv €1u ^ . ty 1v z €v1x ^ t v1gv . u . z }# €' Ex 1uv . 1 d # . . ~ | . v z v1 . xu ^ ' z . # ? 1Uryv . 1S v . uv €1gv . t ^ ty v1z- 1a . . }r s , . 1v ~ f w y }v €= 1S v €€11R ^ t } t ^ Ex v €1z €1 d ty €v }# }v z t19 ? S ? 1sv z1Rh V : 1r €xv t # . vs # t S v . uv €? 11

Sv' x }z ty 1uv . 1d # w }# €' Ex 1z t1' ^ 1sv . . t | t z y t z v €= 1ur t t z €1uv ~ 1W }# z €1uv ~ 1| v z €v1 , uv . 1€ ^ . 1v z €v1 | }v z €v1 k S z ty v €v z €t f v z t ^ Ex 1% . yr €uv €1z t # = 1uz v1 . v t z % 1cv z ty S v z v1uv t1 , . # t w . €v1cv tv . %& t ty ^ # v t1v ~ f > v €u }zt yv . 1z t # = 1r }t1uz v1uv t1Uz t # €' t ty ^ # v t1uv . 1w y }v . sv # . w w €1 }v z €' Ex ?1R ^ t1uz v t v ~ 1X . . €u1 ~ ^ t t1uv . 1

1

V.uwy}v.scztyf Ex t% .x}vzty 1 t t y € v}jv .1r }t1uzv 1C>v 1k, €v 1uv t1, .}tw.€v €1U z t r €' t t y ^ # v t 1 r ^ t } t v € = 1 Š v € € 1 u z v t v d v } | t % p t 1 v z € ^ y r } t v € 1 z t t ?

h v x v € 1 u v t 1 .v } r t % t v } t v € v € 1 R ^ v .v t v € t 1 y, t y, y ~ z v .1V .uwy}v .= 1 u z v 1 % € 1 u v .1 B ? 1 k, € v 1 u v t 1 U z t r € ' > t t y ^ # v t 1 € z y t 1 v .w t t t 1 Š v .u v € = | r € € 1 r ^ w v z € v 1 % ~ 1 V .uwy}v .t t y ^ # 1 r € x v t t, ü v € v 1 R h V 1 % . . z t y t v } t 1 Š v .u v € ? 1

W } x v € u v 1 v z t v } } € x v € 1 | € € v € 1 v € t t f .v t y v € 1 u v € 1, s v € 1 x v t v } } t v € 1 W .u v . . € x v € K 1

1 ö s v . t t , ~ r € t f .v t y Š v . t 1 Z v o 1 C A A 1 1 E A A R 1

1 _ ^ } t f r € € ^ € x t > R € t f .v t y Š v . t 1 f A O 1 D = F 6 1 f A 1

1 k v z % . . x v . . € x 1 9 f ^ k : 1 t v w 1 N 1 B A A ~ t 1

1 g v . x } v z t y t % . w y . v € 1 1 d z € r } % . x } v z t y 1

U z v 1 .v } r t % t | ^ . . v 1 k v z % . . x v . . € x 1 t t v } } t 1 ' Š r . 1 u z v 1 d v } | t % p t 1 t z t y v . = 1 z t 1 r s v . 1 Š p y . v € u 1 u v . 1 R h V > a r ^ t v € ' v z t 1 f . . s } v ~ r t z t y ? 1 S v z l v z € v . 1 R h V 1 r ^ w u v ~ 1 a r . r } j v } t t v ~ 1 t t v } } t 1 z € 1 u v . 1 c v x v } 1 u r t 1 f A O > \ . z v . z ~ 1 z € 1 u v . 1 a r ^ t v € ' v z t t z t y v . = 1 u r t t 1 u v . 1 V . u w y } v . s c z t y f Ex t % . x } v z t y t t t y ^ # 1 ^ . . . t | v } } t t ?

S v z l v z € v . 1 R h V 1 r ^ w u v ~ 1 v z v € v € 1 d t t v ~ 1 ~ ^ t t 1 u v . 1 V . u w y } v . s c z t y f Ex t % . x } v z t y t t t y ^ # 1 v € t Š v u v . 1 v s v € w } } t 1 v z € f, } x 1 z € 1 u v . 1 w y } v . s v y r w v t v € 1 a y r t v 1 r ^ t } t v € 1 ^ € u 1 v z € v 1 R h V 1 r € t t, ü v € 1, u v . 1 v . 1 ~ ^ t t = 1 w } } t 1 v . 1 u . v z f, } x 1 r ^ t } t t = 1 Š p y . v € u 1 u v . 1 R h V > a r ^ t v € ' v z t 1 s }, t | z v . t 1 Š v . u v € 1 9 r ^ t y 1 % ~ 1] v z f Ex t u z w > . v € t z } t t y ^ # : ? 1

1

D?C?E! cvt ~vv!

U v . 1 v z € t r # 1 v z € v t 1 V . u w y } v . s c z t y f Ex t % . x } v z t y t t t y ^ # v t 1 ~ r t y t 1 u r t 1 d t y ^ # t t t v ~ 1 ^ € € t z x 1 | , ~ f } v < 1 ^ € u 1 ~ r t y t 1 r ^ t y 1 u z v 1 d t y ^ # f . . w € x v € 1 € z y t 1 v z € w t y v . ? 1 f € t v . 1 R s Š p x ^ € x 1 u v . 1 g, . . > 1 ^ € u 1 ~ r t y v z } v ~ f > w y } v € 1 u z 1 g v . w t t v . = 1 u r t 1 c z t z , 1 ^ 1 r | ^ v f t z v . v € = 1 u r t t 1 u v . 1 U z t r € ' t t y ^ # 1 t v y . 1 y, t y, y ~ z v . 1 V . u w y } v . 1 € z y t 1 v . | v € € t ? 1 U z v t v 1 W y } v . 1 Š v . u v € 1 u ^ . t y 1 u v € 1] v z f Ex t u z w . v € t z } t t y ^ # 1 r s x v t t y r } t v t 1 s v ' z y ^ € x t > Š v z t v 1 Š . u v € 1 t z t y 1 € r t y 1 v z € z v . 1 k v z t 1 ^ 1 v z € v ~ 1 € z v u v . . y ~ z x v € 1, u v . 1 ^ 1 v z € v ~ 1 ~ v y . f, } x v € 1 W y } v . 1 v € t Š z | v } € ? 1

U z v 1 V . w y . . € x 1 y r t 1 x v ' v z t = 1 u r t t 1 v z € 1 v z t y t t r . | 1 % . . x v . t v . 1 V . u w y } v . t t y ^ # 1 9 \ f c k @ f c : 1 t, Š, y } 1 s v z - 1 a . . w € 1 ^ € f . . s } v ~ r t z t y t z t r } t 1 r ^ t y 1 € z y t 1 ^ . . l ö s v . w € | t z € 1 € v z t ? 1

S v z l v z € v . 1 R € . v x v v z € t v } } € x 1 u v t 1 U z t r € ' t t y ^ # 1 c R N D A 1 9 ~ 1 E A A | g ≥ v t : 1 Š z u 1 v ~ f w y } v € 1 v z € v € 1 ^ > t p # z t y v € 1 V . u | ^ . . t t y } ^ t t t t y ^ # 1 ^ 1 z ~ f } v ~ v € t z v . v € ? 1

1

1

1

1

1

D?E M] v z ^ € x t u z w w v € t r } t t y ^ t ^ 1

D?E B I R } x v ~ v z € v l S v t r t y ^ € x l

Svz- 1] v z ^ € x t u z w w v € t r } t t y ^ t ^ 1 s v x . v € ' v € l u z 1 d ^ ~ ~ v l u v . 1 ^ v t t w y j v . 1 9 h r € u j v . w y j v . = 1 ' s v . t t y S € > x ^ € x v € = 1 d € t y . . € z r t z € t w y j v . : 1 € u l u z 1 R s j v z t t . . ~ v 1 9 u ? y 1 u v . 1] r u v t t . . ~ : l u z 1 V ~ f v € u } z t y | v z t ? 1 1

R } t 1] r u v t t . . ~ 1 w . 1 v z € v 1 E A A | g > W v z j v z ^ € x 1 | r € € 1 t € z t y v . S v z t v 1 B 1 R @ ~ 1 ^ € u 1 w . 1 v z € 1 \ r s v } 1 B I 1 R @ ~ 1 9 (v 1 e v z j } v z v . : 1 r € x v € , ~ ~ v € 1 S v . u v € ? 1 1

g , € 1 v z € v ~ 1 Y v . t t v } j v . 1 S z u 1 v ~ f w y j v € = 1 u v € 1 ^ ^ } p t t x v € 1 U z w t t . . ~ 1 r ^ w u r t t r ? t C f > w t y v 1 u v t 1] r u v > t t . . ~ v t 1 u v . 1] v z ^ € x 1 v z € ^ t t v } j v € l l r t y . x t y € ^ € x v € 1 ~ z 1 d z ^ ^ } r t z € t ~ , u v } j v € 1 u v t 1 c v } r z t 1 v z x v € 1 r s v . = 1 u r t t 1 u z t v 1 v z € t t v } } € x 1 t v y . 1] , € t v . % o t z € t ? 1 U z 1 w j x v € u v € 1 S v t r t y t ^ € x v € 1 s v ^ z y v € 1 t z t y 1 r ^ w u z 1 v z € > t t v } j v ~ f w y } € x 1 u v t 1 Y v . t t v } j v . t ? 1 1

e(€ z t t y v 1 v z € t t v } } S v . t v 1 w . 1 u v € 1] v z ^ € x t u z w w v € t r } t t y ^ t ^ 1	1
W . 1 1 W v z j v z ^ € x v € 1 ~ z 1 v z € v . 1] p € x v 1 M B F A ~ 1	EAAR1
W . 1 1 W v z j v z ^ € x v € 1 ~ z 1 v z € v . 1] p € x v 1 O B F A ~ 1 1	GAAR1

U z v 1 r t t p t y j z t y v 1 v ~ f v € u } z t y | v z t 1 } z x t 1 € z v . z v . = 1 u r 1 u z 1 d t y ^ t ^ v z € . z t y t ^ € x v € 1 S v z v . v 1 W y j v . 1 s v . . . t | > t z t y t z v € 1 9 ? S ? [z t v . 1 u v . 1 , ~ ~ ^ € z r t z € t % . s z u ^ € x = 1 d t . . ~ S r € u j v . t p t t x ^ € x 1 v t ? ? 1

U z v 1 v ~ f v € u } z t y | v z t 1 | r € € 1 v . y y 1 S v . u v € = 1 S v € € 1 U z w w v € t r } t t y ^ t ^ v z € . z t y t ^ € x v € 1 ~ z 1] r u v t t . . ~ | , ~ > f v € t r t z € 1 v z € x v t v t ^ 1 S v . u v € ? U z t 1 v . w . u v . t { v u , t y 1 u v € 1 R € t t y } t t 1 u v . 1 c v } r z t 1 € z t y t 1 € ^ . 1 r € 1 d t . . ~ > 1 t , € u v . € 1 r ^ t y 1 r € 1 d f r € € ^ € x t S r € u j v . ? 1

W . 1 Y (S . z u j v z ^ € x v € 1 9 v z j v . . | r s v } t v 1 W v z j v z ^ € x v € : 1 t z € u 1 v ~ f v € u } z t y v 1 R € t f . x t y S v . t v 1 ~ v z t v € t 1 € ^ . 1 ~ z 1 Y z j v 1 u v . 1] r u v t t . . ~ | , ~ f v € t r t z € 1 ^ 1 v . . v z t y v € ? 1 U z 1 g v . w t t v . 1 t t y } r x v € 1 % o . = 1 t v z j v . . | r s v } t v 1] v z ^ t ^ € x v € 1 r s 1 v z € v ~ 1] r u v t t . . ~ 1 % € 1 B F A R 1 z ~ v . 1 ~ z 1 v z € v . 1] r u v t t . . ~ | , ~ f v € t r t z € 1 r ^ t ^ ^ . . . t t v € ? 1 1

c v r } z t v . s r . v 1 V z € t t v } } S v . t v 1 w . 1 u v € 1] v z ^ € x t u z w w v € t r } t t y ^ t ^ 1 ~ z 1] r u v > t t . . ~ , ~ f v € t r t z € 1	1
c v z € v 1 W v z j v z ^ € x v € 1	CAAR1
e v z j v . . r s v } t v 1 ^ € u 1 t v z j , ~ f v € t z v . t v 1] v z ^ € x v € 1	CAAR1 1 EAAR1
e v z j v . . r s v } t v 1 ^ € u 1 t v z j , ~ f v € t z v . t v 1] v z ^ € x v € 1 ~ z 1 v z € v . 1 t t y } } s r . v € 1 \ , ~ > f v € t r t z € t t f ^ j v t z ~ 1] v z ^ € x t ^ ^ x 1	EAAR1 1 GAAR1

X v j x v € t z t y 1 S z u 1 v z € v 1 ^ z € u v t t v z € t t v } } € x 1 % € 1 B F 6 1 u v t 1 ~ r < z ~ r j v € 1] r t t t . . ~ v t 1 r } t 1 ^ } p t t x v . 1 U z w w v € t r } t t . . ~ 1 v ~ f w y j v € ? 1] r s , . . € t v . t ^ t y ^ € x v € 1 % € 1 R ~ f . z € 1 ^ € u 1 % € 1 e v € € v e 1 ^ v z x v € 1 { v u , t y = 1 u r t t 1 u z t v 1 W . u v . . € x 1 ^ 1 f v t t z ~ z t z t y 1 z t t ? 1 V z € v 1 ^ z € u v t t v z € t t v } } € x 1 % € 1 H F 6 1 u v t 1 ~ r < z ~ r j v € 1 S v t . z s t > t t . . ~ v t 1 S z u 1 r } t 1 r ^ t . v z t y v € u 1 s v t . r t y t v t ? 1

1

1

1

1

W...1uzv1X...€uvz€t} €x1uv†1Uzw.v€€z}†ty^ † vt†t€u1uzv1Wyr €fr†† €x1svzlvz€v..1t†yr }sr.v€1
 \, ~ fv€tr †z €††f^ }v1^ €u1uzv1d†... ~ v=1uzv1†ty1r^ †tvz€v..1uv~ 1cv}r†1€zty†1xv€r^ 1sv|r €€tv€1dfr €>
 €^ €x†%..†vz} €x1r^ wuv..1}v† €x1v.xvsv€1| €€v€=1^ 1sv...t| †zty†zv€?†}v† †v.v†1Š zu1fr^ †tyr}1~ †1
 F6 1uv†1} ruv††., ~ vt†r €xv€, ~ ~ v€L1uv..1W | †. .1C=F 1w}x†1uv..19| , €tv.%€†%€: 1V~ fwy} €x1uv†1Yv.>
 ††v}}v..†?

$$X...€uvz€t} €x1 \quad 1 \quad h \quad c^{a\%} \quad QKT \quad \frac{h_{iu}}{Q} \quad OKOT \quad I \quad h_{bk^a} \quad 1 \quad 1 \quad 9X \} ?D>D: 1$$

Uzv1Vz€t} €x1uv†1^ }††z€v1Uzw.v€€z}††., ~ vt††, }†v1{vu, ty1H=F6 1uv†1~ r<z- r}v€1}r†††., ~ vt††
 €zty†† €tv..†ty.vz€v?

D?F|| dr ~ ~v}†tyzv€v€†ty^††1

Uv..1R€†f.vtyŠv..†1uv†1dr ~ ~v}†tyzv€v€uzw.v€€z}†ty^ † vt†1~ ^††1v~ fv€€u}ztyv..1r}†1uv..1~ z€z- r}v1
 \^ ..†ty}††††., ~ 1^ €u1†, }†v1r^ ††dzyv.yvz†x...€uv€1, sv.yr}†1uv†1~ r<z- r}v€1}r†††., ~ vt†1uv†1r~ 1
 y ty††v€1sv}r†††v€1Rs' Š vzv†1vz€xv††}††Š v..uv€?†f €†v..1Sv...t| †zty†z^ €x1vz€v..1dzyv.yvz†.xtv.%€1
 Š zu1v~ fwy}v€=1uv€1R€†f.vtyŠv..†1uv†1dr ~ ~v}†tyzv€v€†ty^ † vt†1r^ wuv€1dty^ † x.v€'††., ~ 1uv†1
 r~ 1y ty††v€1sv}r†††v€1Rs' Š vzv†1vz€^††v}}v€?†

Svz1R€}r xv€1z€1_v††r^††} w.€=1svzlvv€v1vz€v1ösv...xr | †z €1uv†1dr ~ ~v}†tyzv€v€†ty^ † vt†1€zty††^ 1
 vz€v..1X...ù†† ..€x1uv†1v^ ..f†z†tyv€1gv.s^ €uv€† vt†1wy..†=†| r €€1%€1uzv1v..1Vz€t}v}}v~ fwy} €x1rs>
 xvŠ ztyv€1Š v..uv€?†

D?G||]vz††^€x††tyr}†v.%v...†rxv...†ty^††1

d†r €u1uv..1evty€z†z†1vz€1z- 1dr ~ ~v}†tyzv€v€†ty^ † 19ddd: 1z€†v.x.z.v..1]vz††^€x††tyr}†v.%..†rxv.>
 †ty^ † 19]dg: ?†Uv..1R€†f.vtyŠv..†1uv†1dtyr}†v.%..†rxv..†ty^ † vt†1~ ^††1^ ~ 1vz€v1dzyv.yvz††w| †. .1
 €zv.u.zv..1r}†1uv..1~ z€z- r}v1^ ..†ty}††††., ~ 1svzlvz€v~ 1W}y}v..1%..1uv~ 1, ww€v€1V€uv1uv..1Xvxv€††r>
 †z €1vz€xv††}††Š v..uv€?†

Uv..vz†1.vr}z†v..†v1V~ fv€€u}zty vz†1	BCAAR1
cvr}z†v..sr.v1V~ fv€€u}zty vz†1 11	CEAR1 1GAAR1

1

Uzv1V~ fv€€u}zty|vz†1uv†1}vz††^€x††tyr}†v.%..†rxv..†ty^ † vt†1~ ^††1†, 1vz€xv††}††Š v..uv€=1ur††1W}y}v..1
 r~ 1xvxv€ sv.}zvxv€uv€1, ww€v€1}vz††^€x††v€uv1†ztyv..1v..†r €€††Š v..uv€?†z€1uv..1cvxv}1u ..†v1r^ ty1z€1
 k^ |^ €w1uzv1uv..vz†1.vr}z†v..†v1V~ fv€€u}zty|vz†1r^†.vztyv€19%}††Š zu1E>B: =1vz€v1y yv.v1V~ fv€€u}zty>
 |vz††††1rsv..1 1w}††v.w.uv..zty1 1f...s}v~ }, †1.vr}z†v..sr..z†

Z€1%}v€1R€}r xv€1z†1uv..1ddd>R^†svwy}z- 1{vŠ vz††r^††^††} tv€uv€1W}u1~ †1vz€v~ 1, |r}v€1Wvzrsv>
 |.z†v.z~ 1f_U>%..| €fv†19 ?†S?†~ †1vz€v~ 1ösv..††., ~ |.z†v.z~ : =1^ ~ 1vz€v1W}y}r^††}†† €x1uv†1ddd1
 †ztyv..1^ 1%..~ vzuv€?†Uzv††1Wvzrsv|.z†v.z~ 1Š.z|.††r^†ty1ur €€=†Š v€€1uv..1ddd1r}†1}vz††^€x††tyr}>
 †v.%..†rxv..†ty^ † 1r.svz†††^ €u1svx.v€'††ur~ †1uv††v€1V~ fv€€u}zty|vz†1Vz€v1R}†v.€r†z%1^ ..1ösv.>
 ††., ~ wwzrsv1z††1uz1gv.Š v€u^ €x1vz€v††z- fvur€'|.z†v.z~ †=1w}††††r^†vz€v1Wvzrsv1uv†1dr ~ ~v}>
 †tyzv€v€†ty^ † r^†svwy}††€zty††%}}| , ~ ~ v€1%..†zty†††Š v..uv€††, }††11

1

r^ tylyv^ tv1tty, €1t, =r^ ?IS?IS v€€1v€1\^ ..tty}^ tt1r^ vw€v..1Y tyttfr€€^ €xt>d tzy}vz^ €x1€^ ..1%€1 v€v~ 1e.r.€tW... r^ ,.1r^ t1uv..1BBA|g>Vsv€v1xvtfvz†S zu?11

Uzv1~ €z- r}v€1\^ ..tty}^ tttt...~ v1S^ .uv€1r^ ty1€1k^ |^ €v1€zty†€zv..zv..1r}tyv^ tv1tv€?1

^ €uv†tv€†s†1CACC1tvz1€zty†- z†v€v~ 1| .z†tyv€1Rst€| v€1uv..1\^ ..tty}^ tt}vz†^ €x1^ 1.vty€v€?11

1

E?D|| Uv%v}, f ~ v€†1, w1R%orz}rs}v1dy, ...†Tz...t^ z†1a, Šv...1z€1Xv... ~ r€€1w..., ~1CABB1^ f††, 1 CADD1IBn1^ €u1Uv€r>d†^ uzv1d€††v ~ uzv€††}vz††^ €xv€1CADA1IDn1

Svz1IBn1yr €uv}†1v1†tzy1z- 1h vtv€††ztyv€1^ ~ 1v€v1\^ ..w††^ €x1uv..1Uv€r>d€††v ~ uzv€††}vz††^ €xt> †† uzv11Dr?1Uv..1Sv.r.ty†^ €xt^ vz.r.^ ~ 1v..†.vt|††tzy1s†1CADD?1

Svz1uv..1Sv†.r.ty†^ €x1S^ .uv1uv..1R^ tsr^ 1uv..1.xv€v.r.†%€1V..1v^ x^ €x†r€}xv€1^ €u1uv..1_v† v1r^ t1 uv~ 1_v† v€†S z†|}^ €xt†}r€1CABD19d^ v€r.z 1w..1CADA:1r}†1u^ .tyxvwy..†1sv†.r.ty†v†?1R}†1V.xvs€z†1z†1 w††^ yr}†v€=1ur††1uzv1~ €z- r}v€1†, Š zv1uzv1~ r<z- r}v€1\^ ..tty}^ tt}vz††^ €xv€=1S^ v}tyv1†tzy1 z- 1Sv†.r.ty†^ €xt^ vz.r.^ ~ 1CABB1v.xvs€v€1yrsv€=1r^ ty1w..1ur††1[ry..1CADD1€zty††^ €†v..>1s^ Š ?1 sv..†ty..z††v€1S^ v..uv€?1Uzv1w}xv€uv1Rssz†u^ €x1r^ t1uv..1d† uzv1^ vx†1uz†v€1dr ty%..yr}†1w..1uzv1 ~ €z- r}v€1\^ ..tty}^ tt}vz††^ €x=1S^ v}tyv1w..1uzv1W€| †€1uv..1dty^ † v€..zty†^ €xv€1v€††tyvzv€u1z††?



Abbildung 4.4 Darstellung der Kurzschlussleistung im Minimalfall in den Jahren 2011 und 2033 bezogen auf den Knoten mit der größten Kurzschlussleistung (Knoten 20) im Jahr 2011

1

Uv..1~ r<z- r}v1\^ ..tty}^ tttt...~ 1z- 1uv^ ††tyv€1ösv..†.rx^ €xt†v† 1sv†.1x1z- 1[ry..1CABB1tr?1HF1|R=1 uzv††z††€1uv€1Rssz†u^ €xv€1uv..1d† uzv€1r}†1BAA6 1r€xv†v† †?1Z€†v..vt†r€†v.Švzv†††vz†1uzv1\^ ..> tty}^ tt}vz††^ €x11€1uv€1s†ztyv..1|^ ..tty}^ tttt...~ ttyŠrtyv€1\€, †v€1uv†1_v† v†19uz††z††1%..1r}v~ 1 uv..1., .u, ††v€1Uv^ ††ty}r€uf: 1vyv..1r€=1S^ py..v€u1v..1€1uv€1s†ztyv..1|^ ..tty}^ tttt...~ ††.}.v€1\€, †v€1 9uz††z††1%..1r}v~ 1ur††c^ y.xvsz†† 1vyv..1†z€|†?1Uv..1c t|sr^ 1%€1\ .r.v€1v€1~ z†1d€ty...€~ r†tyz> €v€1^ €u1v€v1v€v..v1gv...r†ty^ €x1uv†1_v† v†1u^ .ty1_v† r^ tsr^ 1^ €u1uru^ .ty1††vzv€uv€1\^ ..> tty}^ tttt...~ v1S^ .uv€1sv...t|†zty†z†?

1

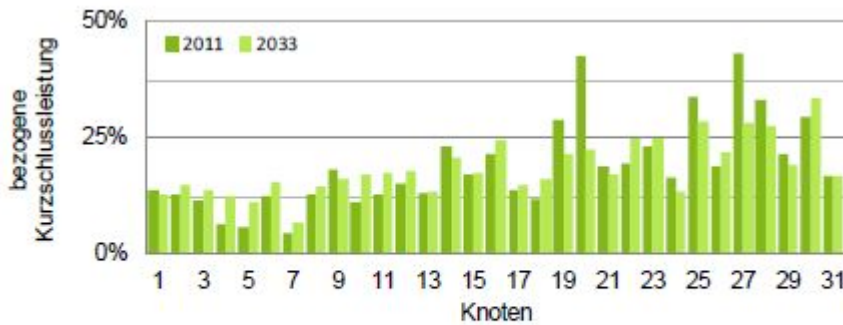
1

1

E?M k^tr ~ ~v€wr††^€x1^€u1Sv^...†vz}^€x1

W..ldty^ † vz€.zty† €xv€1v€††tyvzv€u1†€u1v€v..†vz†1uv..1~ z€- r }v1^ ^..†ty} ††††.,~ =1uv..1r€1v€v~ 1 cv)r zrv€sr^ ,.†1^ 1v.Šr.†v€1z†††† €u1r€uv.v..†vz†1uv..1~ r<z- r }v1]r††††.,~ ?1Ur1uv..1~ z€- r }v1^ ^..†ty} ††††.,~ 1z- 1gv.s^ €u€v† 1xv€v€ sv..1yv^ †v1€zty††sv†v€†}zty1| }v€v..1Š zu=1.vzty†1uz/1uv..†vz1.vr > }z†v.†v1v~ fv€u)zty|vz†1uv..ldty^ † vz€.zty† €xv€1z- 1Y ty††††††€€^ €x†€v† 1z- 1X...,üv€1^ €u1Xr€^ v€1 r^ ty1w..1uzv1k^ |^ €w†1r^ ††1V†Š r†1%v.z€wty†| r€€1w††xvyr }†v€1Š v.uv€=1ur††z1k^ |^ €w†1uv..1^ ^..†ty} ††††.,~ 1uv..†v€zv1d†.,~ 1z††=1uv..1%€1uv€1| r††v€1r^ w...€u1uv†1dfr €€^ €x††.zty†v..†1€zty†1~ vy..1 r^ wv€.,~ ~ v€1Š zu† €u1uv..1†zty†r€1uv..1^ ^..†ty} ††††††}†v1 tr ~ ~ v}† ?1

^ ^..†ty} ††††††^ † vz€.zty† €xv€1sv€ †zv€1v€v€1sv†z- ~ †v€1^ z€uv††††.,~ ?1Uz†v1Š^ .uv€1z€1\rfz- †v}1D1uz†|^ †z.†?11

Uz†1Y yv1uv†1^ ^..†ty} ††††.,~ v†1†v}†††z††††(vu, ty1z€1Y ty††††††€€^ €x†€v† v€1| vz€1v.w.uv.)ztyv†1 \.z†v.z - K11

- || Uz††€^ .v}r z†1r.svz†v€1~ z†1uv..1Wyy}v.z- fvur€^ =1r }†, 1uv~ 1b^ , †zv€1v€1r^ †††† €u1Z1^ €u1†z€u1 uryv..1 ††, }r€xv1uv..1^ z€uv††††.,~ 1v...vzty††Š zu1>1%€1uv..1Y yv1uv†1^ ^..†ty} ††††.,~ v†1† €> rsyb€xz?11
- || Uz†w.v€†z }†ty^ † vz€.zty† €xv€1szüv€1ur†1\z.tyy, w†tyv1Xv†v†† 1rs=1€r ty1uv~ 1r€1vz€v~ 1 \€, †v€1z€1(vuv~ 1]vz†v..1uzv1d^ ~ ~ v1r }†v..1d†...v1_ }†††v€1~ ^†††z††uzv1d^ ~ ~ v1uv..1d†...v1 ^ €x}vzty1_ }††††, 1wü††uz†v..1 Uz†w.v€^ ††.,~ 1z.xv€uŠ, 1y€=1Š, 1v..1€zty††y€xvy .†K1††††††€> uv)††zty1^ ~ 1v€v€1Wyy}v..1z- 1_v† ?1R^ ty1y†v..1z††1uz†1r st, }†v1Y yv1uv†1d†.,~ v†1† €Š zty†z=1 v..w.uv.)zty1z††€^ .=1ur††1uv..1Uz†w.v€^ ††.,~ 1uv€1vz€†††}†v..††††††, 1uv€1z€1\rf?1D?C1r^ wv> wy.†v€1^ z€uv††††.,~ =1 sv..†ty.vz††††††1111

Z- 1W }xv€uv€1Š zu1uzv1Rs€ry~ v1uv†1^ ^..†ty} ††††.,~ v†1svz1}r€xv€1Y ty††††††€€^ €x††vz†^ €xv€1 9D1 A|g:1z- 1^ Š vzf, }zv€1Wyy}v.w}†ur.xv†††}††††††€xv€, ~ ~ v€1Š^ .uv€1vz€1u.vzf, }zv..1^ ^..†ty} †† > ††.,~ 1%€1C=†| R19..† 1s^ Š ?1†| R19}r^ :1z- 1c t|v€1uv†1cv)r z†1^ €u1vz€1] zty†s, xv€Š zuv..†† €u1%€1 CA ?11

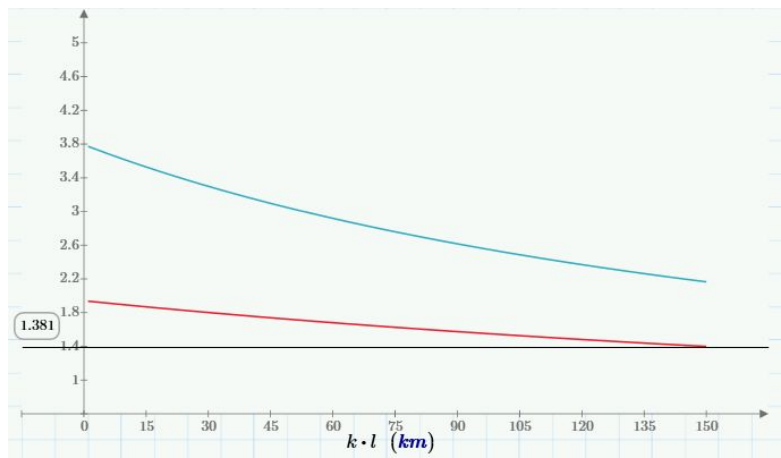

1
1
1
1
1
S zu 1E > B1
k Š vzf, }zv..1 ^ ^..†ty} ††††.,~ 1 z€1
Rsyb€xz | vz†1%€1uv..1Wyy}v.v€†>
w.€^ €x1
1
1

Vz€1^ ^..†ty} ††††.,~ 1%€1B=D| R1Š zu1r^ ty1svz1Wyy}v.€1r ~ 1V€uv1vz€v..1}r€xv€1]vz†^ €x1€zty††^ €†v.> †ty.z††v€?1Uz†1xvŠ }†}†v€1cr€usvuz€x^ €xv€1†††}†v€1r^ ty1z€1k^ |^ €w†1vz€v€1†vy..1fv††z- z†††tyv€1W }††† ur..=1uv..1†.,~ † uv~ 1%€1uv€1^ ^..†ty} ††††††^ † vz€.zty† €xv€1f...s }v~ }, ††svyv...†ty††Š zu†

1

F1 gv...r...svz... Ex11%, €1^ vttx... ùv€lz€ldty^...v}rzt11^ €u1R€w, ...uv...^ €> xv€1r€1uv...v€1b^ r}z}p}t}

F?B|| ` sv...t tyŠz€x^ €xv€lz€l^ vttx... ùv€1

Uz1 s}z}y v1^, uv}}%o..t}v}} €x1svz1uv..1svf.r.ty} €x1%o€1` sv..t tyŠ z€x^ €xv€1xvy}1ur %o€1r^ t=1ur t}t1 r€xv}t ty}, t}v€v1Xv..p}v1` sv..t tyŠ z€x^ €x t}t...~ „^ v}}v€1t}z€u=1r}t, 1` sv..t tyŠ z€x^ €x t}t...~ v1z€1ur t1 _v} 1v€1f v z}v€?Uz v t}t ty}z}ùv€1t}z}y1

- » sv..b^ v..|r fr' }p}v€1uv t1_v} v t}19%o..1r}}v~ 1y yv..x1Wv„^ v€' v€: 1
- » sv..1 y~ t tyv1gv.s.r^ tyv..1
- » z€1uv€1d€ty...€xv€v.r} .v€19%o..1r}}v~ 1€zv.u.zv1Wv„^ v€' v€: 1
- » } t tyv€1t}z}y1xv xv€1v z}x 1u^ .ty1 €}v..t ty z}v}z}tyv 1ayr tv€}r xv1r^ t}B11

1

Ur t1w}xv€uv1S}zu1F>B1t}v}}t1uz}tv1k^ tr~ ~ v€yp€xv1ur ..Z1Z€tsvt, €uv..x1Š zu1ur ..r^ Wyz€xvŠ z}tv€=1 ur t}t1^ ^ }z}v}%)>f ~ .z}y}v..k}v€r^ t, 1Š z}v1d€ty...€~ r t ty z€v€1r}t1dv€|v1w..1 sv..t tyŠ z€x^ €x t}t...~ v1 €zv.u.zv..1 .u€^ €x1uz}v€1} €€v€?

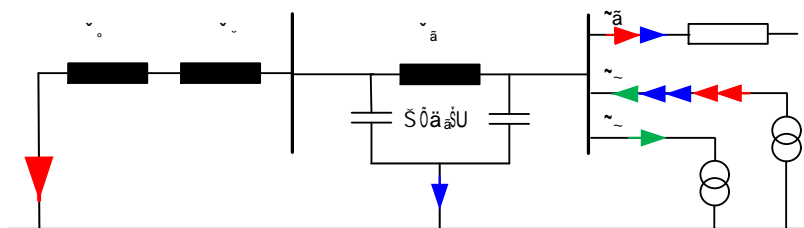
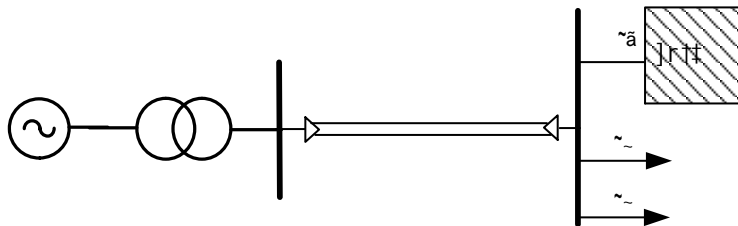

sv..t tyŠ z€x^ €xv€

- ➔ €zv.u.zv..1 .u€^ €x=
- ➔ y yv..x..1 .u€^ €x t €u
- ➔ R^ t} t ty^ €x

1

1

S}zu1F>B1R^ ts.vz} €x1%o€1 sv..t tyŠ z€x^ €xv€1€zv.u.zv..1 €u1y yv..x..1 .u€^ €x1t, Š z}v1R^ t} t ty^ €x1Jn1

1

Z€1uv..1c}vr}z}p}t}v€1}t}v}v€1` sv..t tyŠ z€x^ €x t}t...~ v1€z}y t}€^ .1u^ .ty19}v z}t} €x t}v}v} | t...€z}t}y v1Xv..p}v1 t, €uv..€1r^ ty1u^ .ty1€z}y t}z€vr..v t1gv..yr}t}v€1x}r€' 1€, ..r}v}..1_v} sv}z}v}t~ z}t}v}=?S?1u^ .ty1d}p}t}z} x^ €x1uv t1~ r x€v}z}t}tyv€1\..v z}t}v1%o€1e.r€f}w...r} .v€?U^ .ty1uz}v1^ r x€v}z}t}z}v...€x t}v€€}z}z}v1S v..uv€1

B1Svz1 sv..t tyŠ z€x^ €xv€19 d 1uz}v1€v€v..1w}t}v€1ayr tv€}r xv1^ .1_v} t}fr€€^ €x1r~ 1}v}v}z}xv€1Xv..p}t}v€1}t}v}v€=1}r€€1uv..1 Vw}t}uv..R^ t} t ty^ €x1%o~ 1}r t}t} t}t}Š z}tyv€1uv€R€ty} t}t} €|}v€1uv..1 d}v...v^ xv..1sy}p€xv€?Sv}z}v}z€v~ 1}r t}t}z€|v}p}€1 B1A€FND€t} Š z}tyv€1C1R€ty} t}t} €|}v€1} t ty}t}z}y1v}z}v1^ .1}v}v}z}xv€1d}fr€€^ €x1f}y}r tv€1€ty...€z}z}v..t}v}F?1' d}1%o}}}, ~ > ~ v€1^ t}?

1

r € 1 v z € v ~ 1 v f 1 ~ z 1 t z € t w ... z v ... 1 d f r € € € x 1 ` s v . t t y S z € x ^ € x t t t ... ~ v 1 v ... v x f ? 1 h v € € 1 t z y 1 u z / t v 1 ... s v . t t y S z € x ^ € x t t t ... ~ 1 € z y t r ^ t s . v z v € 1 | € € v € 1 > 1 1 ? S ? S v x v € 1 v z € v . 1 a , } t v } v z - 1 v f 1 > 1 u r € € 1 t . v t v € 1 u z / t v 1 g v ... v ... € x v € 1 ~ t , 1 - v y . 1 z 1 u v . 1 d f r € € € x 1 r ^ w ^ € u 1 s v v z € t . p t y t z v € 1 r € u v . v r € x v t t y } , t t v € v 1 g v . s . r ^ t y v . ? 1

h z 1 S z 1 z - 1 W } x v € u v € 1 t v y v € 1 S v . u v € = | € € v € 1 t , S , y } 1 u r t 1 g , . y r € u v € t v z € 1 % € 1 ` s v . t t y S z € x ^ € x t > t t ... ~ v € 1 r } t r ^ t y 1 u v . x € 1 W y } v € 1 ^ 1 ö s v . > 1 , u v . 1 f € t v . w € | t z € v € 1 % € 1 d t y ^ t v z € . z y t € x v € 1 w y . x € ? 1

1

F ? C || R } } x v ~ v z € v t 1 ^ 1 v t t S v ... t % v ... r ... s v z t ^ € x 1 z € 1 d t y ^ t ' ... v } r z t 1

U v . 1 f . z € ' z f z } v 1 R ^ w r ^ 1 v z € v t 1 € ^ ~ v . z t t y v € 1 d t y ^ t x v . p t v t 1 z t 1 z 1 S z u 1 F > C 1 | 1 n 1 u r . x v t v } } t 1 € u 1 s v z 1 r } } v € 1 X v . p t v € 1 x } z y ? 1 1

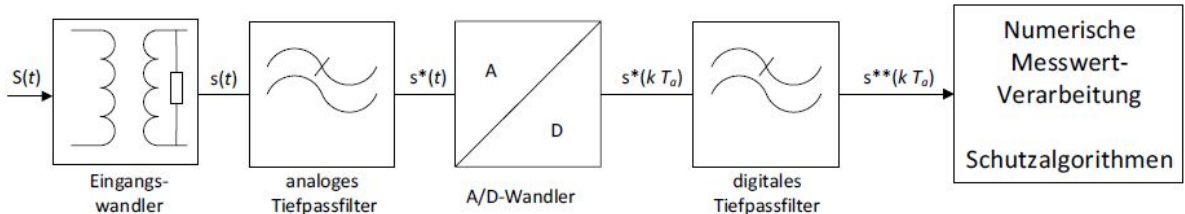

S z u 1 F > C 1 a . z € ' z f z } v 1 R ^ w r ^ 1 v z € v t 1 € ^ ~ v . z t t y v € 1 d t y ^ t x v . p t v t 1 g , . % . r . . s v z t ^ € x 1 u v . 1 d z € r } v 1 | 1 n 1

f € t v . t t y z u v 1 v . x v s v € 1 t z y 1 { v u , t y 1 u ^ . t y 1 u z v 1 R ^ t } v x ^ € x 1 u v . 1 v z € ' v } € v € 1 \ , ~ f , € v € t v € K 1 1

- ⊳ V z € r € x t S r € u } v . 1 9 z v € x v t t y } , t t v € 1 , u v . 1 - z 1 } ^ w t f r } t : 1
- ⊳ r € r } , x v € 1 e z w f r t t v z v . 1 s ' S ? 1 R € t z R } z t z € x > W } t v . 1 9 v t | w w , ^ v € ' 1 € u 1 d t v z y v z 1 u v t 1 W } t v . t : 1
- ⊳ R @ > h r € u } v . 1 9 R s t t r . t v : 1 1
- ⊳ u z z r } v t 1 W } t v . 1 9 W } t v . % . w y . x € = 1 v € x ... ü v € : 1 € u 1 u v . 1
- ⊳ € ^ ~ v . z t t y v € 1 g v . r . s v z t ^ € x 1 9 R } x , . z y ~ ^ t : 1

h p y . x € u 1 u z 1 d t y ^ t x v . p t v 1 s v z 1 . v z € 1 t z € t w ... z v € 1 d z € r } v € 1 ~ z 1 v € € w , ^ v € ' 1 z - 1 h v t v € t } z t y v € 1 z - ~ v . 1 u z / t v } s v € 1 v . x v s € t t v 1 } z w . € 1 ^ € u 1 z € 1 u v . 1 c v x v } 1 r ^ t y 1 r ^ v X } z t y t t , . ~ x } z u v . 1 ^ € v - f v € u } z t y 1 . v r > x z v . x € = t v z v € 1 t z y 1 s v z 1 1

- ⊳ R s S v z t y ^ € x v € 1 % € 1 u v . 1 v € € w , ^ v € ' 1
- ⊳ v z € v ~ 1 y , y v € 1 R € t v z 1 % € 1 s v . t t y S z € x ^ € x v € 1 ^ € u 1
- ⊳ ' ^ t p t } z t y v € 1 ^ } } u ^ . t y x p € x v € 1 z € 1 u v € 1 d z € r } v € 1

u v ^ t } z t y v 1 f € t v . t t y z u v 1 ^ S z t t y v € 1 % . t t y z u v € v € 1 d t y ^ t f . z € ' z f z € 1 9 d t , . ~ = 1 z - f v u r € ' = 1 U z w . x € t z r } t t , . ~ : 1 € u 1 % . t t y z u v € v € 1 v . t t v } v . € ? 1

1

F ? D || R € w , ... u v ... ^ € x v € 1 r € 1 u z v 1 b ^ r } z p t 1 % , € 1 \ ^ ' t t y } ^ t t t t ... ~ v € 1

U r 1 r } } v 1 y z v . 1 s v t . r t y t v t v € 1 d t y ^ t x v . p t v 1 w . 1 u z 1 v . | v € € ^ € x 1 v z € v t 1 \ ^ . t t y } t t v t 1 u z 1 X . : € u t t y S z € x ^ € x 1 r ^ t S v . t v € = ^ t t 1 u z / t v 1 r ^ w { v u v € 1 W } } 1 s v z 1 v z € v ~ 1 \ ^ . t t y } t t 1 z € 1 r ^ t . v z t y v € u v ~ 1 ^ r ü v 1 z € 1 u v € 1 d f r € > € ^ € x t > 1 ^ € u @ u v . 1 d t , . ~ x ... ü v € 1 ^ . 1 g v . w x ^ € x 1 t t y v v € ? 1 U v . 1 v z 1 x z t 1 v t 1 | v z € v . } v z 1 g , . x r s v € = 1 S z v 1 v z € 1 \ ^ . t t y } t t t t , . ~ 1 r ^ t ^ t v y v € 1 y r t 1 z € w } x v u v t t v € 1 S p . x 1 r ^ t y 1 v z € 1 d t , . ~ 1 x v ~ ? 1 S z u 1 F > D 1 v z € 1 ^ } p t t z v . 1

1

Uzvw.v€taz.v}rzt1svzvz€v~ 1z€tv.€v1Wvy}v..1uv€1y, yv€1 sv..ttyŠ z€x^ €xtr€tvz}rjt1d€... Š r€u}v..tpz> t€x^ €x 1z€tv..f.vtzv.v€T €u1uzv1R^ t} t^ €x1s}, t|zv.v€?11

1



1

SzuF>D1^ ..tty} tttt€... ~ 1- z1vz€v~ 1v< t.v~ 1y, yv€1R€tvz}r€T sv..ttyŠ z€x^ €xv€1

1

W..€v..1zt1^ 1sv...t| tztvz€v€1ur tt1vz€v1dty^ f.f. z€v€1xv^ z}t1 sv..ttyŠ z€x^ €xttt€... ~ v1r^ tS v..> tv€1^ ~ 1Wvy}w€| z€ €v€1^ 1%... vav€=1svztfz}tŠ vztv1uzv€v1uzv1C?>tv1^ €u1F?>tv1Y r... , €zttyv1^ ..1 S}, t|zv..€x1uv1t1e.r€tw... r z€ .Uzvw.v€taz}tty^ f vt1svz- 1Vz€ttyr}tv€1s' Š ?1svz1ösv.v...x^ €x?1Ur1 v€v1f €tv.w€| z€ 1%€1dty^ f xv..p1v€1z- 1R€w.uv...€xtw}}1r^ txvttty}, ttv€1S v.uv€1~ ^ tt=1u ..w€1 ^ sv..ttyŠ z€x^ €xv€1uzv1v..1^ .u€^ €x1z- 1^ ..tty} tttt€... ~ 1€zty1r}t1gv..tty~ ^ f^ €x1u^ .ty] vzt€ €xt> v}v| t€..€z1 r^ v.v.v€?1Vt1S zu1%..xvttty} xv€=1uzv1] t|v1y z€tztv}ztv1wy}v€uv..1R€w.uv...€xv€1r€1uzv1 b^ r}z}p1uv1t1^ ..tty} tttt€... ~ vt1^ 1tty}zvüv€?1

1

Vt1tz€u1^ z€uv1tr €w..uv... €xv€1r€1uzv1b^ r}z}p1uv1t1^ ..tty} tttt€... ~ vt1r^ t1V..> ' v^ x^ €xtr€}rxv€1~ zt1] vzt€ €xtv}v| t€..€z1 19y zv...^ 1' py}v€1r^ ty1d€... ~ .zty tv..1 %€1X}vzty ttt€... ~ %..sz€u^ €xv€: 1^ 1uvvz€zv.v€1^ ~ 1r^ ty1z€1k^ | ^ €vt1f €tv.w€| z€> , €v€1uv..1dty^ f v z€..zty€ €xv€1tztv..1r^ tttty}zvüv€1^ 1] €€v€?1

1

1

F?€|| R€w, ...uv...^ €x1r€1uzv1b^ r}z}p1%, €1d€... ~ v€1z~1_ , ... ~ r}svf...zvs1

R€uv.v..tvz}1sv€ z€v€1dty^ f v z€..zty€ €xv€1rsv..1r^ ty1^ sv..ttyŠ z€x^ €xttt€... ~ v^1^ ~ 1z- 1^ €xvtt€ .> tv€1Sv€ zvs1ösv.w€| z€ €v€1^ 1%... vav€=1r jt1Svztfz}1y zv..w..1uzv€v1uzv1sv.vz}t1v..Š py€tv€1C?1Y r..> ~ , €zttyv1svz- 1Vz€ttyr}tv€1%€1e.r€tw... r z€ .v€1^ €u1uzv1F?1Y r... , €zttyv1svz1ösv.v...x^ €x?1Uzvtv1 u ..w€1vz€v..tvz}1z- 1W}v1vz€v1t1^ ..tty} ttvt1€zty1 Š z}j| .}zty 1%€1}vzt€ €xtv}v| t€..€zttyv€1Xv..p> tv€1v..v^ x1S v.uv€=1r €uv.v..tvz}1u ..w€1d z1z- 1_ , ... r}svf...zvs1rsv..1r^ ty1€zty1^ €tv.u...t| t1S v.uv€1 t, €uv.€1~ ttv€1uv€1 €r z€ .}ztyv€ 1Xvxvsv€yvz}v€1uv1t1_v f vt1v€1tf..xtyv€1l BBn?1Vz€1Xvur €|v€svz> tfz}1~ xv1uzv1v..p^ tv.€K1S v€€1vz€1e.r€tw... r z€ .19- z1cv~ r €v€: 1r€1vz€v1d€... ~ , ^ v}}v1xvttty}tv€1 Š zu=1uzv1vz€v1.vz€1t€^ tw... zv€1d€... ~ 1vz€1fvz}t1S zu1uzv1dfr €€^ €x1v< t.v~ 1%...v...f1uv..1Vz€> ttyr}tt€... ~ 1rsv..1S zu1] vz€v1C?1Y r... , €zttyv1v€tyr}tv€?1Z€w}xvuv1tv€1] r€€1ur1t1e.r€tw... r z€ .uzw> .v€taz.v}rzt1S}tyvt1uv€1Vz€ttyr}t%..xr €x1r€yr €u1uv..1C?1Y r... , €zttyv€1z- 1d€... ~ 1v..v€€v€1] r€€=1 €zty1t1r s}z}t v.v€1^ €u1S zu1wy}r^ t} tv€?11

^ sv..ttyŠ z€x^ €xttt€... ~ v^1 uzv1uv€1 €r z€ .}ztyv€1_v f vxvsv€yvz}v€1v€1tf..xtyv€1~ ttv€1 vzvüv€1 | €€v€?1Y zv..1sv€ z€v€1uzv1^ sv..ttyŠ z€x^ €xttt€... ~ v1vz€v1 dv€|v ?1Z€1yv..| ~ ~ }ztyv€1_v f v€1

1

szuv€1uz/1a, }rutfr€€ Exv€1%€1d... Exv€v.r.€ .v€1- z1v€xvf .pxiv..1t€^ tw... zv..ldfr€€ Ex1 v€v1v€€tf. .xtyv€uv1dv€|v?1Z€1}vz#^ Ex tv}| €., €z >sr tzv. tv€1_v# v€1| €€tv€1uzv1dv€| v€1u^ .ty1 v€v1v€€tf. .xtyv€uv1d tv^ v... Ex1%€1f ~ .ztytv.€1- z1a^ }fŠvzv€~ , u^ }r tz €11v. tv# #Š v.uv€?1Z€tsv> t, €uv.v1uzv1v€xvf .pxiv1€ryv^ ^ 1t€^ tw... zv1dfr€€ Ex1%€1^ ^ }tz} v%>d€., ~ .ztytv.€1t#}1v€v1 zuvr }v1dv€| v1ur .?11Z€t, w.€1v..tttyv€1v1€zty1#^ z}wy.v€u=1^ sv..tttyŠ z€x^ Ex t#f... ~ v1€zv.vzv..1^ .u> €€ Ex=1uz1u^ .ty1uz1^ sv..tttyŠ z€x^ Ex t#f r€€ Exv€1uv11_v# v1v€# tvyv€=1r€1^ ^ }tz} v%>d€., ~ > .ztytv.€1^ 1^ €tv.s€uv€?1

Uv..1Wv, ^ v€^ sv.vzty=1uv€1uzv1dty^ #^ .v}z1sv€^ z€xv€=1^ ~ 1t, Š, y}f €fv.>1r }1r^ ty1ösv.w€| z€ Ev€1 t#tyv..1^ €fv.s€uv€1^ | €€v€=1t#t€1SžU1F>E1s}r^ 1ur .xv#tv}#?1

1

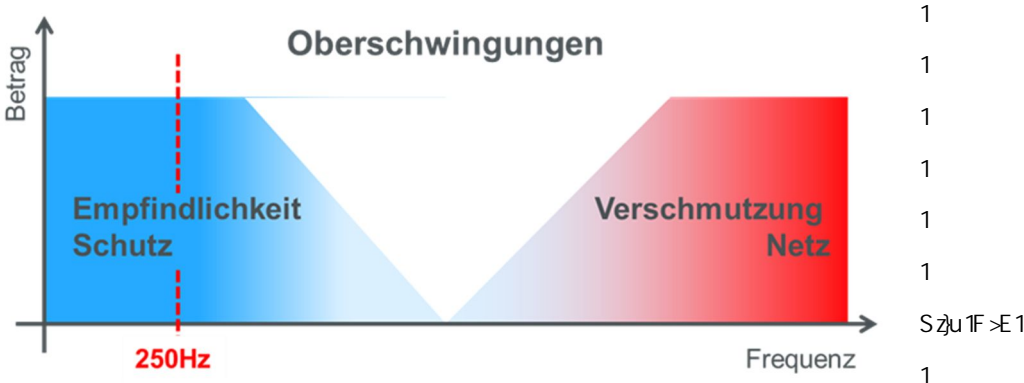

1

F?F k^ tr ~ ~v€wr t#^ €x1^ €u1R^ ts}zt |1

R€1uzv tv..1d tv}v1|, €€tv€1€^ .1x..sv1k^ tr ~ ~v€yp€xv1sv ttty.zvsv€1Š v.uv€?1Ur t1xvtr ~ tv1eyv~ r1z€1 r }1tvz€v€1k^ tr ~ ~v€yp€xv€1€zty1#z1r^ t.vztyv€uv~ 1^ rüv1v.w..ttty?1Sv€^ z€x1Š z u1vz€v1X...€u}r> xv€w..ttty^ Ex=r^ t1uv.v€1V.xvs€z#tv€1uz1R€w.uv... Exv€1w..1^ | €wzv1#tvty€ztyv1R€ttty}^ tt.zty}z> €zv€1w..1uz1k^ |^ €v1yv.xv}zv#1Š v.uv€1| €€v€19fzvvr^ ty11 n?

k^ tr ~ ~v€w t#tv€1v.xvsv€1t#zty1w}xv€uv1R€w.uv... Exv€1r€1uv€1^ ...ttty}^ ttt#., ~ K1

- z1v€vz#^ Ex1vz€v1r^ t.vztyv€u1y, yv€1X...€uttyŠ z€x^ Ex t#f... ~ v11^ .1t#tyv.v€1R€v.vx^ Ex1 %€19^ ...ttty}^ t#>1dty^ # xv.p#tv€1
- gv...vz#^ €x1^ €|, €#., }zv..tv.1v€vz#^ Ex1%€1 sv..tttyŠ z€x^ Ex t#f... ~ v€1z- 1^ ...ttty}^ t#> t#., ~ =1uz1r}f1S}, t|r uv| .zv.z ~ 1w..1dty^ # w€| z€ Ev€1%€1.Š v€uv#1Š v.uv€19 ?1S?1C?> Yr... , €ztyv1^ €u1F?>Yr... , €ztyv1w..1S}, t|r uv1Uzw.v€z#}ty^ # r^ t} t^ Ex: 1
- v€v1^ Š r€xyrvw1f €fv.u...t|^ Ex1%€1^ sv..tttyŠ z€x^ Ex t#f... ~ v€=1uz1uzv1dfr€€ Ex t#> , ^ r}z#tz- 1_v# 1%€1.svttv.€1^ €u1uz1uzv1dty^ # v€z.zty#^ Exv€1sv€^ z€xv€1
- Svx.v€^ ^ Ex1uv11dfr€| €., ~ t1uv..1%€1V..v^ x^ Ex tr€}rxv€1- z1]vz#^ Ex tv}| €., €z 1v- z# z€z.v€1 sv..tttyŠ z€x^ Exv€1z- 1^ ...ttty}^ ttt#., ~ 1z- 1sv.vzty1AY' 1sz11- z€uv#tv€1FAAY' 1
- d^ s>1^ €u1kŠ ztyv€yr... , €ztyv1t, }v€1z- 1^ ...ttty}^ ttt#., ~ 1€zty1r^ v.v#tv€1
- v€v1V..v^ x^ Ex1^ t#^ }tyv..1^ }u^ .tyxp€xv1u^ .ty1 sv.}rxv. tv1^ sv..tttyŠ z€x^ Exv€1 Š py.v€uvz€v..1X...€uttyŠ z€x^ Ex t#fv.z uv1



1

» \vzv1gv.ttyzs^ €x1uv..1_ ^}}u^ .tyxp€xv1uv..1X... €utty\$ z€x^ €x1u^ .ty1^ sv..tty\$ z€x^ €>
xv€1

» gv..z vzu^ €x1xv.r.u' r y}zv..1Yr... , €ztyv..11

1

1

||

1

1

G1 Y yv...r^t}rt^€xluv...l_v^v1

G?B|| R}}xv ~ vz€v†1

kŠ ztyv€1uv~ 1kzv}1uzv1dty^ † x.v€' †... ~ v1^ 1v.y yv€1^ €u1uv..1R^ wv sv1uv..1dty^ † vz€..zty† €xv€=1 r^ ty1svz1^ €x €†zv€1Wvy}v.., €†v}}r †z €v€1^ ..1.tty} ††v1†ztyv..1^ €u1†v}v| †z%r s' ^ †tyr}†v€=1sv††vy† vz€1dfr€€^ €x†%..yb}†€z†1R^ †1uzv†v~ 1X...€u1| €€v€1sv††z~ ~ †v1v€††v}}fr..r~ †v..1€zty†1Š vzv..1.v> u^ ^zv..†1Š v..uv€1L1€†sv†, €uv.v1uzv11v€††v}} €x1uv..1D?k, €v1††v}}†1~ †k_D 11BE 1>1B|__11v€v1uv.r..†zv1 X.v€'v1ur..†r^ ty1| €€v€1sv††z~ ~ †v1sv†.zsv†, €'vf†v1uzv1dztvy..††v}} €x1v€v..1^ €rsyp€xzv€1ö sv.> ††..~ r€..vx^ €x1z~ 1Yr^††ty^ † sv.vzty1v..w.uv.€?e.., † uv~ 1z†1v€v1V.y y^ €x1uv..1dty^ † x.v€' > ††..~ v1uv^ †zty1 sv..1ur†1sztyv.zv1^ rü1y€r^†1~ x}zty=1v..w.uv.†1rsv..1v€v1\, ~ s€r †z €1%€1z~ 1 W}xv€uv€1xv€r€€†v€1^ rü€ry ~ v€?

Uv..1dty^ † x.v€' ††..~ 1Š zu1r^†1uv..1R€..vzv€††v}} €x1uv†1Uz††€' .v}†19yav..1z~ 1h vt€††ztyv€1uzv1 v€††v}} €x1c_R_1r^ wuv..1cv††z††€' rtytv: 1^ €†v..1Sv...t| †ztyz^ €x1%€1dztvy.yvz††w| †.v€1^ €u1uv†1 ~ r<z~ r}r^ w.v†v€uv€1| r††Š €|v}†1sv.vty€v††z~ 1_v† wy...€x††††v~ 1Š zu1r^†1uv~ 1dty^ † x.v€' > ††..~ 1%_dX: 1u^ .ty1^ ^ }†z}†r †z €1~ †1uv~ 1†.r€†z€†v€1dztvy.yvz††w| †.1uv..1V€xfr††††..~ >dty^ † 1 %_v€x:d: =1Š v}tyv..svz1uv..1_v† †ztyv.yvz††.vty€^ €x1r}†1X..v€' Š v.†1 sv.Š rty†1Š zu†1

k^ tr ~ ~ v€xvw†††kz††w..1uv€1V€xfr††††..~ >dty^ † 1 11

$$1 \quad 1 \quad 1 \quad 1 \quad h_{d^{\circ}r} \quad \int_t I h_{rf} 1 \quad 1 \quad 1 \quad 1 \quad 1 \quad 1 \quad 9X \} ?IG>B: 1$$

$$\wedge z1uv~ 1dty^ \dagger x.v\epsilon' \dagger\dagger.. \sim 11 \quad h_{rf} \quad \int_t \frac{t}{\sqrt{R}} \quad \int_q I \int - \quad \alpha \pm \mu \quad k_{eff} I \frac{P}{q \cdot m} 1 \quad 1 \quad 9X \} ?IG>C: 1$$

$$\S zu1 \quad 1 \quad 1 \quad 1 \quad h_{d^{\circ}r} \quad \int_t I \int_t \frac{t}{\sqrt{R}} \quad \int_q I \int - \quad \alpha \pm \mu \quad k_{eff} I \frac{P}{q \cdot m} 1 \quad 9X \} ?IG>D: 1$$

Yzv..svz††€uK1 1

1	f €1	_v† €v€€†fr €€^ €x1	EAA g19w..1dty^ † : 1
1	w1	dztvy.yvz††w † ..1w..†.r.€†z€†v1R^ tx}vzty†> %o.xp€xv1	A= DD1 1B=A1
1	w1	^ z€~ r}v1dfr €€^ €x1€rty1uv~ 1Wvy}v..1	A= E1>1A= F1>1A=J A1
1	w1	c t w}}%..yb}†€z†1	A=J F1
1	w1	^ v††xv€r^ z vz†19h r€u}v..=1cv}†r: 1	A=J A1
1	t, t }r††1	h z .r€†z}1uv†1dtyv€††..~ v†1	1
		11 1svz1€zv.u.zv€1d††..~ v€1	A=J A1
		1 >11svz1†vy..1y, yv€1d††..~ v€1	A=J HF1
1	c_R_1	R€..vzv€††v}} €x1r^ wuv..1cv††z††€' rtytv1	' ?IS ?IDA f.z.p.1

Uzv1}v† †v€1f €†v..† ty^ €xv€=1uzv1€1uv€1[ry.v€1CAAJ @BA1†††w€uv€=1v.xrsv€1v€v€1u^ ..tyxpe€xz1 .vr}z†z.vr.v€1dty^ † x.v€' ††..~ 1%€1tr ?EEI AR1s' Š ?Vz€v1V€xfr††††..~ >dty^ † 1%€1tr ?ID?HDAR?11 Z€1S}zu1G>B1†z€u1uzv1ur ~ r}†1xv††.. wv€v€1ö sv..}x^ €xv€1^ €u1dztvy.yvz††~ r.xv€1ur.xv††v}}†?

1

1

1

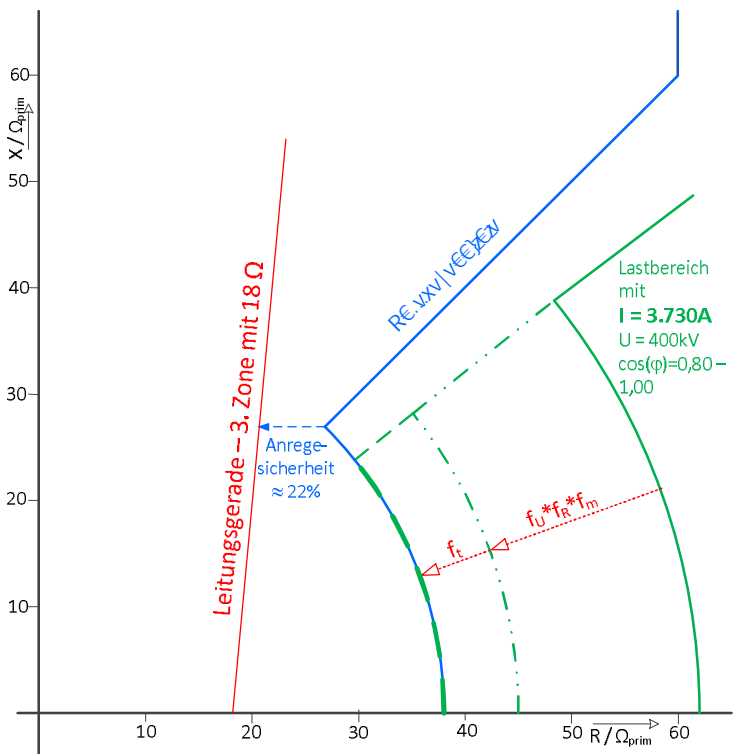

1

1

1

1

1

1

1

1

1

1

1

1

1

1

1

1

dvzvuv~ 1 S ^ .uv€1 uzv1 dty^ † v€ .zty† €xv€1 z~ 1 uv^ † tyv€1 EAA| g>_v† 1 u^ .tyxp€xz1 uzvzv }zv. †?1
Uru^ .ty1v.xvsv€1†ty1€v^ v1^ x}zty| vzv€=1uv€1dty^ † x.v€† t€.~ 1svz1Uz†€€ tty^ † v€ .zty† €xv€1
^ ^ tv.y yv€=1, y€v1uzv1kzv}v11

- ‡ gv... vzu^ €x 1%€1ösv.w€| †z €v€19W}y}r^ t} † €xv€: 1€u1 1
- ‡ V€yr}† €x 1uv..1v.w.uv..}ztyv€1v~ f v€u}zty| vzv11

%€.€rty}††zvv€1^ 1~ †tv€?Z~ 1v€' v}€v€1†z€u1uzv1uzv†k1

- ‡ gv...z€xv...€x 1uv..1R€.vvvtztyv.yvz19%}††f?IG?C1a| †?C: ?11
- ‡ Uzv1R| †zav...€x 1vzv€†1^ ^†† }ztyv€1v~ f v€u}ztyv€1V.u|^ ...ttty} ††ttty^ † vt1szv†v†1uzv1^ x> }zty| vzv=1uzv1R€ .xx^ €x r^ w- vy.f, }zv1^ .ttty} ††v19€u1ur~ z† €v~ f v€u}ztyv...lv€^ ^†v}v€1 9%}††f?IG?C1a| †?1D: ?1
- ‡ V€v1v}†tyv€uv†| v€uv1R| †zav...€x 1%€1av€uv}†fv...v€1szv†v†1uzv1^ x}zty| vzv=r^ wuv€1dtyv..> yvz†w| † .1w..1†.r€†zv€†v1R^ tx}vzty†% .xp€xv† ^ 1%...ztyv€19%}††f?IG?C1a| †?1E: ?1
- ‡ V€v1R€f††€x 1uv†1R€ .vvvf, }€x, €†19sv††v..v.1t, † 1svzly, yv€1d†...~ v€: 1v.w.uv.†1' Š r..1 V€†\$ z|} €x†r^ v\$ v€u^ €xv€1†vzv€†1uv..1dty^ † .v}ztyv..††v}v. =1vzv1z- f}v- v€†z...€x 1%...1 ^ .1†††rsv..1~ z†.v}†z%\$ v€zv1R^ v\$ r€u1u^ .ty1Wz.. Š r..v^ fur†v†1~ x}zty19%}††f?IG?C1a| †?1 F: ?1

W€.€v..1S^ .uv€1s' Š ?1Š v.uv€1z€1uv€1_v† }vz††††v~ v€1W€| †z €v€1^ €u1R}x, .zty~ v€1.vr}zv. †=1uzv1
vzv€1sv††v.v1ösv.Š rty^ €x 1uv†1_v† v†† €u1vzv€1 €}€v>, €†..}v1uv..1dty^ † v€ .zty† €xv€1^ }r††v€=1
Š, u^ .ty1uzv1R^††† €x 1v.y y†Š v.uv€1|r€€=1%}††f?IG?C1a| †?1B† €u1a| †?1G?1

1

1

1

G?C|| ^ x}ztyv|^ rù€ry ~ v€l

B: || ` €}z€v>^, €z, .z€x11

dty^ † v€††v}} €xv€1~ ††v€1†, \$, y}1sv' x}zty1uv†1v. |.v€€v€†1%€1\ ^ ..tty} ††v€1r}†1r^ ty1z- 1Y z€> s}z| 1r^ wuz1gv.~ vzu^ €x1%€1ösv.w€| †z €v€1|, €†v.%€†z%vz€xv††v}}†S v.uv€?1W ..1uz1gv.~ vzu^ €x1 %€1ösv.w€| †z €v€1svuv^ ††1uz†=†ur††1r}}v1~ x}ztyv€1w..1uv€1dty^ † 1~ rùxvsv€uv€1ar .r.~ v†v..1 rsxv†ty†† †S v.uv€1~ ††v€?1W ..1uv€1Uz††€' †ty^ † †z€u1uz††1

- ‡ €zv.u.z††v†Sv†.zsv††fr €€^ €x=1
- ‡ ~ r<z- r}v..1^ v††wy}v..1^ €u11
- ‡ †ty}†ty†††v..†t, †9 : 111

Ur1€zty†1z- ~ v..1 ††, 1\$ zv1s†zyv..1z€1uv..1vz€††v}} €x1sv... t| †zty†z††1>1r}}v1uv..1w..1uz1dty^ † v€††v}} €x1 svx.v€' v€u1\$ z. |.v€uv€1W | † ..v€1x}zty' v†z†1r^ v†.v†v€=1| €€v€1u^ .ty1Y z}w~ z††v}1z- 1_v†† wy...€x†> †††v~ 1dfz}.p^ ~ v1w..1vz€v1y yv.v1R^ ††† €x1v...wz€v†S v.uv€K1

- || U^ .ty1vz€v1€>dztyv.yvz††.vty€^ €x1~ z†1uv€1r | † v}}v€1Sv†.zsv†ur †v€1uv†1_v†† v††1^ €u1 u^ .ty1vz€v1r^ †, ~ r†z†v.†v€1gv.x}zty1uv..1 | r††z- fvur€' v€1€r ty1R^ †w}}1vz€v1Sv> †.zsv†- z††v}†1~ z†1uv€1vz€xv††v}}†v€1R€.xxvf, }€z, €v€1| €€v€1dfz}.p^ ~ v1w..1vz€v1Y > yv.r^ ††† €x11xv€^ † †S v.uv€=†ur1~ v††v€††1dfr €€^ €x1^ €u1†, †9 : 1€r ty1R^ †w}}1vz€v1 Sv†.zsv†- z††v}†1sv††v..1†vz€1\$ v.uv€=†r}†1~ r€1w..1uz1dty^ † v€††v}} €x1r}†1h , ..†††r††v> Sv†.r.ty†† €x1r€€vy~ v€1- ^ †††v?11
- || U^ .ty1gv.Šv€u^ €x1uv..1r | † v}}v€1%€1uv€1dty^ † .v}r†z†1xv~ v††v€v€1Sv†.zsv†S v.†v€1z€1 uv..1_v†† †ztyv.yvz††.vty€^ €x1| r€€1uz1dzyv.yvz††~ r.xv=uz1w..1^ v††wy}v..1%€1h r€u> }v.€† €u1cv}r††svz1uv..1dty^ † v€††v}} €x1sv... t| †zty†z††S z u=1.vu^ ' zv.†S v.uv€?11
- || d, }}1vz€v1\$ z. |.†r ~ v1ösv..††., ~ r€.xx^ €x1v...vzty††S v.uv€=1| r€€1r€††v}}v1vz€v1††† z††tyv€1 R€.xxvS v.†††vz€1r€1uz1\^ ^ ..tty}^ †††z††† €x1r€xv†††††v..1u€€r ~ z††tyv..1h v.†1%€.Šv€uv†† S v.uv€?1

1

C: || R€.xxv†ztyv.yvz††

Sztyv..1\$ zu1svz1uv..1dty^ † v€††v}} €x1vz€v1dzyv.yvz††~ r.xv1%€1CF>DA6 1r}†1R€.xxv†ztyv.yvz†† Š z- ††tyv€1uv..1D?1k, €v1^ €u1uv..1R€.xx^ €x1sv... t| †zty†z††?1Svz1v} | †., ~ vtyr€z†tyv€1^ €u1svz1r€r}, xv}v| †> .., €z†tyv€1dty^ † .v}r†z†1\$ r..1uz††1^ Š z€xv€u1v.w.uv.}zty=†ur 1R€.xx^ €x1^ €u1k, €v€~ v††^ €x1{vS v}z††1r}†1 vzxv€v11Sr^ x...f.fv€1~ z†1zy.v€1{vS v}z††1vzv€v€1Sr^ †v}z†, }v.r€' v€1r^ †xvwy.†1Š r..v€?1Svz1uzz††v€1 cv}r†z†S v.uv€1uz1r€r}, xv€1h r€u}v.x...ùv€1{vu, ty1€^ ..1vz€~ r}†uzz††z†v.†† €u1r€††ty}zvùv€u1\$ v.uv€1 †, \$, y}1w..1uz1k, €v€~ v††^ €x1\$ zv1r^ ty1w..1uz1R€.xx^ €x1uz1†v}sv€1uzz††z†v.†v€1h v.†v1€^ ~ v.†ty1 r^ †xvS v.††† 1Sr^ †v}z†, }v.r€' v€1†.v†v€1ur yv..1€^ ..1vz€~ r}†1r}†1W}v}v..1r^ wUr1~ z††v.Švz}v1z- 1Y d> _v†† 1u^ .tyxp€x1uzz††v1dty^ † vz€.zty†† €xv€1z€††r}}zv.†††z€u=1| r€€1uv..1R€.xxv†ztyv.yvz††w| †, ..1 %€1uv..1.vz†††r?1DA6 1r^ vsvz††z†††S v††v1BF6 1.vu^ ' zv.†S v.uv€?1

1

1

1

